

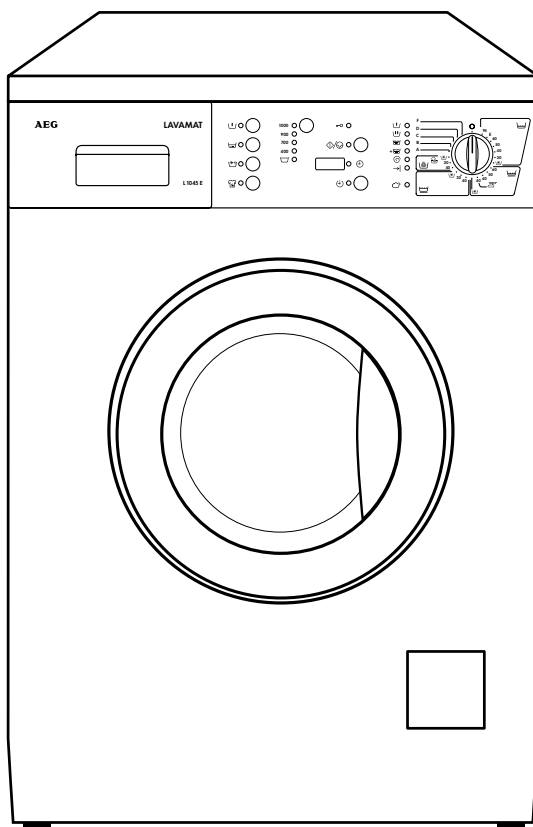



LAVAMAT L 1045 E

The environmentally friendly washing machine
Instruction booklet



Dear customer,

Please read these operating instructions carefully and pay particular attention to the safety notes indicated in the first pages. We recommend that you keep this instruction booklet for future reference and pass it on to any future owners.

-  The warning triangle and/or the key words (Warning!, Caution!) emphasize information that is particularly important for your safety or correct functioning of the appliance.
-  This symbol guides you, step by step, in the operation of the appliance.
-  The information marked with this symbol provides additional instructions and practical tips on the use of the appliance.
-  Tips and information about economical and ecological use of the machine are marked with the clover symbol.

Should any problems arise, this booklet provides instructions on how to solve them by yourself; see section "Something not working?".

If this information is not sufficient, please contact our nearest SERVICE CENTRE (address and telephone numbers are indicated on the enclosed leaflet).

Printed on recycled paper.
People who think ecologically, act accordingly...

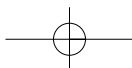

Contents

| | |
|--|-----|
| Safety instructions | 5-6 |
| Disposal | 7 |
| Tips for environmental protection | 7 |
| Main features of your washing machine | 8 |
| Description of the appliance | 9 |
| Control panel | 10 |
| Programme selector dial | 10 |
| START/PAUSE button | 11 |
| DELAY START button | 11 |
| Programme Option buttons | 12 |
| STAIN | 12 |
| QUICK | 12 |
| SOAK | 12 |
| PREWASH | 12 |
| SPIN SPEED | 13 |
| RINSE HOLD | 13 |
| Display | 13 |
| Programme progress display | 14 |
| Cancelling a programme | 15 |
| Altering a programme which is running | 15 |
| Opening the door after the programme has started | 15 |
| Detergent dispenser drawer | 16 |
| Before the first wash | 16 |
| Preparing the wash cycle | 17 |
| Sorting out and preparing the laundry | 17 |
| Weight of laundry | 18 |
| Types of fabric and care labels | 18 |
| Detergents and additives | 20 |
| Which detergent and additive? | 20 |
| How much detergent? | 20 |
| Liquid detergent | 20 |
| Adding a water softener (descaling product) | 20 |
| Information on water hardness | 20 |

Contents

| | |
|--|-------|
| How to wash | 21 |
| Load the laundry | 21 |
| Add detergent and additive | 21 |
| Selection of the desired wash programme | 22 |
| Selection of the desired options | 22 |
| Selection of the SPIN SPEED or RINSE HOLD option | 22 |
| Selection of the EXTRA RINSE | 23 |
| Selection of the DELAY START option | 23 |
| Starting the programme | 24 |
| At the end of the programme | 25 |
| Programme charts: wash and special programmes | 26-27 |
| Cleaning and maintenance | 28 |
| After each wash | 28 |
| Periodical cleaning | 28 |
| Exterior | 28 |
| Detergent dispenser drawer | 28 |
| Door seal | 29 |
| Drain filter | 29 |
| Water inlet filter | 29 |
| Emergency emptying out | 30 |
| Frost precautions | 30 |
| Something not working? | 31 |
| Troubleshooting | 31-33 |
| Unsatisfactory washing results | 34 |
| Technical data | 35 |
| Service | 36 |
| Instructions for installation and electrical connection | 37 |
| Safety instructions for the installer | 37 |
| Dimensions of the appliance | 38 |
| Front view and side view | 38 |
| Rear view | 38 |
| Installation | 39 |
| Unpacking | 39 |
| Positioning | 40 |
| Levelling | 40 |
| Water inlet | 40 |
| Water drainage | 41 |
| Electrical connection | 41 |
| Permanent connection | 42 |

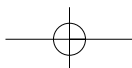

Safety instructions

The safety of AEG appliances complies with the industry standards and with legal requirements on the safety of appliances. However, as manufacturers, we feel it is our duty to provide the following safety notes.

General safety

- Repairs to the machine must be carried out only by qualified personnel. Repairs carried out by inexperienced persons could cause serious danger. Contact your local AEG Service Force Centre.
- Never start the machine if the electrical supply cable is damaged or the control panel or worktop are so damaged that inner components can be reached.
- Unplug the appliance before carrying out any cleaning or maintenance operations.
- Never pull the power supply cable to remove the plug from the socket; always take hold of the plug itself.
- Never spray the machine with a jet of water. Danger of electric shock!
- During high temperature wash programmes the door glass may get hot. Do not touch it!
- Let the water cool down before carrying out emergency emptying or before opening the door in an emergency.
- Small animals can gnaw electric wires and water hoses causing electrocution hazard and damage due to water leaks.

Positioning, connection, starting up

- Follow the **instructions for positioning and connection**.
- Carry out a first wash without laundry (COTTONS 60, with half the amount of detergent) in order to remove any manufacturing residue from the tub and the drum.
- Should the machine be purchased in winter, when temperatures can be below 0°, leave the appliance for 24 hours at ambient temperature before starting it.

Safety instructions

Child safety

- Children are often not aware of how dangerous electrical appliances can be. When the machine is working, children should be carefully supervised and not be allowed to play with the appliance - there is a risk that they could become trapped inside.
- The packaging components (e.g. plastic film, polystyrene) can be dangerous to children - danger of suffocation! Keep them out of children's reach.
- Keep all detergents in a safe place out of children's reach.
- Make sure that children or pets do not climb into the drum.
- When the appliance is to be scrapped, cut off the electrical supply cable and destroy the plug with the remaining cable. Disable the door catch in order to prevent children from becoming trapped inside while playing.

Proper use

- This appliance is designed for domestic use only. If the machine is used for any other purposes or is not used correctly, the manufacturer accepts no responsibility for any damage that might occur.
- For safety reasons, the appliance must not be modified.
- Use only detergents suitable for washing machines and follow the manufacturer's instructions.
- Garments which have been in contact with flammable solvents should not be machine washed.
- Do not use your machine for dry cleaning.
- Dyes and bleaching agents may only be used if specifically permitted by the manufacturer of these products. We cannot be held responsible for any damage.
- Always unplug the appliance and turn off the water tap after use.



Disposal

Packaging materials

The materials marked with the symbol  are recyclable.

>PE<=polyethylene

>PS<=polystyrene

>PP<=polypropylene

This means that they can be recycled by disposing of them properly in appropriate collection containers.

Machine

Use authorised disposal sites for your old appliance. Help to keep your country tidy!



Tips for environmental protection

To save water, energy and to help protect the environment, we recommend that you follow these tips:

- Normally soiled laundry may be washed without prewashing in order to save detergent, water and time (the environment is protected too!).
- Use the energy saving programme when washing normally soiled garments.
- The machine works more economically if it is fully loaded.
- When small loads are washed, use only half to two thirds of the recommended amount of detergent.
- With adequate pre-treatment, stains and limited soiling can be removed; the laundry can then be washed at a lower temperature.
- If the water has a medium or high degree of hardness (starting from hardness degree II, see "Detergents and additives") water softeners must be added.

The amount of detergent can then be adjusted to hardness degree I (= soft).

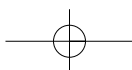

Main features of your washing machine

- Programme and temperature setting using the programme selector.
- **Stain programme** for effectively treating stained washing.
- **Energy saving programme** for normally soiled cotton items.
- **Speed for the final spin** can be reduced to 900, 700 or 400 rpm.
- **RINSE HOLD**: the laundry is left immersed in the final rinse water to prevent creasing.
- **Delay timer**: programme start can be delayed by 1 to 19 hours (e.g. to times with a more economical power rate).
- **Programme progress display** showing the programme steps selected and the programme phase which is running.
- Because of its gentle washing action, the **special wool cycle** washes your garments with extreme care.
- **3-compartment drawer** for detergent and fabric softener.
- **Unbalance detection device**: to prevent vibration during spinning.

Description of the appliance

Front view

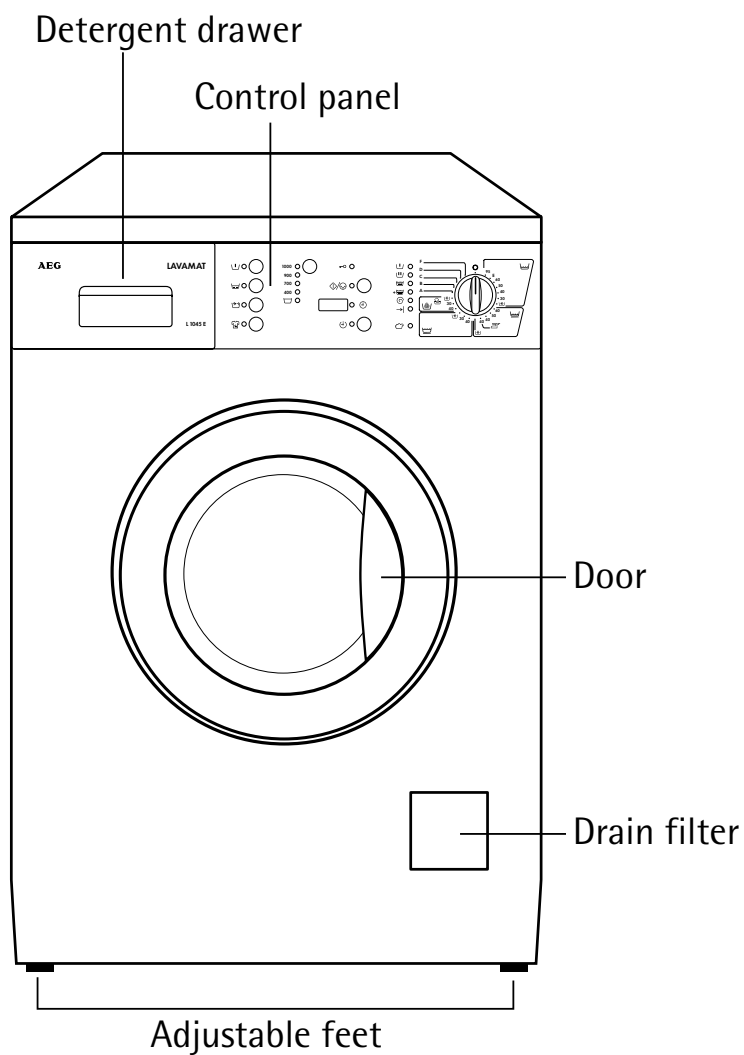

Control panel

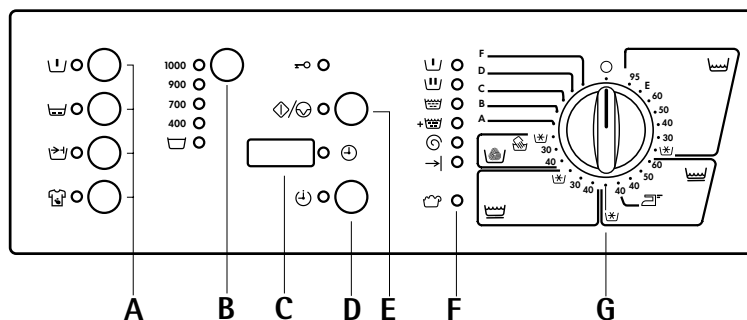

- A = Option buttons
- B = Spin speed button
- C = Display
- D = Delay start button
- E = START/PAUSE button
- F = Programme progress display
- G = Programme selector dial

Programme selector dial

The programme selector determines the type of washing cycle (e.g. water level, drum movement, number of rinses) and the washing temperature according to the type of laundry.

The selector dial is divided into 5 sections:

- Cottons
- Synthetics
- Delicates
- Woollens (hand washing)
- Special programmes

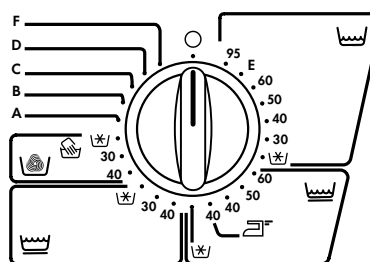

The selector dial can be turned either clockwise or anticlockwise.



Position **E** corresponds to the ENERGY SAVING programme at approx. 67°C for normally soiled laundry, extended washing time (cannot be combined with QUICK).

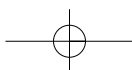

Description of the appliance

Position  at 40°C = Easy to iron.

In this position the laundry is gently washed and spun to avoid any creasing. In this way ironing is easier.

Position  = cold wash

Position  = reset programme/switching off

START/PAUSE button

This button has three functions:

a) Start

After having selected the required programme, press this button to start the machine. If you have selected the DELAY START option , the machine starts its hourly countdown.

b) Pause

To interrupt a programme which is running, press the START/PAUSE button: the corresponding pilot light starts to flash.

To restart the programme from the point at which it was interrupted, **press the START/PAUSE button again.**

c) Empty out water

At the end of a programme which ends with water in the drum (RINSE HOLD  option), press the START/PAUSE button to empty out the water: the machine will empty and spin.

DELAY START button

The wash programme can be delayed from 1 hour up to a maximum of 19 hours.

The button must be pressed after selecting the programme and before pressing the START/PAUSE button.

The figures indicating the delay appear for about 3 seconds in the display. The duration of the selected wash programme is then displayed. After depressing the START/PAUSE button, the machine starts its hourly countdown.

To alter or cancel the preset delay, press the START/PAUSE button, then press the DELAY START button until the required time is displayed or, if you wish to cancel the delay, until the symbol h is displayed.

Then press the START/PAUSE button again.

When the delay is cancelled, the display shows the duration of the wash programme previously selected.

Description of the appliance



Programme Option buttons

Depending on the programme, different functions can be combined. These must be selected after choosing the desired programme and before depressing the START/PAUSE button.

When these buttons are pressed, the corresponding pilot lights come on. When they are pressed again, the pilot lights go out.

STAIN

To treat heavily soiled or stained laundry with stain remover (extended main wash with time optimised stain action phase, **not** selectable for wool or programmes with temperatures lower than 40°C).

This function **cannot** be used with QUICK , SOAK  and PREWASH .



QUICK

By pressing this button the washing time is reduced. For use when washing lightly soiled laundry.

This option is **not** available with the wool and economy programme and **cannot** be used with STAIN .

SOAK



The machine performs a soak of about 30 minutes at 30°C. By pressing the DELAY START button  the soak time can be prolonged up to 10 hours max. After this time the wash cycle will automatically start.

This function **cannot** be used with WOOL, PREWASH  or STAIN  programme.



The soak programme ends with a short spin in programmes for Cotton and Synthetics, and with emptying of the water without spinning for Delicates.



PREWASH

The machine performs a prewash cycle at 30°C max. The prewash cycle ends with a short spin in programmes for Cotton and Synthetics, and with emptying of the water without spinning for Delicates.

This option is **not** available with the wool programme and **cannot** be used with SOAK  and STAINS .

For use when washing heavily soiled laundry.

Important: By depressing at the same time buttons  and  the machine will perform an extra rinse (see page 23)

By depressing at the same time buttons  and  the acoustic signal at the end of programme is switched off.

Description of the appliance

SPIN SPEED

Press this button to reduce the maximum speed of the final speed proposed by the machine for the selected programme or to select option  (RINSE HOLD).

The maximum spin speed for cotton is 1000 rpm, for synthetics and wool 900 rpm and for delicates 700 rpm.

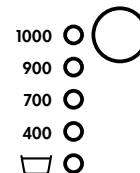
**RINSE HOLD **

By selecting this option, the last rinse water is not emptied out, to prevent the fabrics from creasing. When the programme has finished, the pilot light  (END) on the programme progress display illuminates to indicate that the water must be emptied out.

To empty out water:

- press the START/PAUSE button: after emptying, the machine performs the spin cycle required for the type of wash selected;
- select the spin speed and press START/PAUSE;
- select the DRAIN programme "C" to empty out the water without spinning.

Warning! The programme selector dial must be turned first to RESET  and then to the DRAIN programme "C".

If the water is not emptied out, the machine automatically empties itself after 18 hours.

Display 

The display shows the following information:







- **Duration of the selected programme (in minutes)**, calculated automatically on the basis of the maximum recommended load for each type of fabric.
- When the programme has finished, **a steadily lit zero** is displayed.
- **Delayed start**, (19 hours max.) programmed using the special button . The countdown is updated every hour.
- **Alarm code** indicating a fault in the machine operation (see page 31).

Description of the appliance

Programme progress display

By selecting the wash programme, the pilot lights corresponding to the various phases making up the programme come on.

After the machine has started, only the running phase pilot light stays on. When the programme has finished, the END → pilot light comes on.



-  ○ PREWASH
-  ○ WASH
-  ○ RINSES
-  ○ EXTRA RINSE
-  ○ SPIN
-  ○ END
-  ○ OVERDOSAGE



When the programme has finished, if the OVERDOSAGE  light comes on, it indicates that too much detergent has been used or that the drain filter is blocked.

Cancelling a programme

To cancel a programme which is running, turn the programme selector dial to the RESET  position.

Warning! After a programme which ends with water in the drum (RINSE HOLD  option), turn the selector dial first to  and then to the DRAIN programme "C".

Altering a programme which is running

To alter a programme, first set the machine to PAUSE by pressing the START/PAUSE button.

Any function can be modified before the machine starts it. After selecting the new option press the START/PAUSE  button again to restart the selected programme.

To modify the selected programme turn the programme selector dial to  and then choose a new programme.

The water is **not** emptied out and after pressing the START/PAUSE button again the machine restarts with the newly selected programme.

Opening the door after the programme has started

To open the door set the machine to PAUSE by pressing the START/PAUSE button.

The door can be opened if:

- the machine is not already heating;
- the water level is not above the bottom edge of the door;
- the drum is not turning.



The light  on the control panel indicates if the door can be opened:

- green light: the door can be opened;
- unlit light: the door cannot be opened;
- flashing red light: the door is open.

Description of the appliance

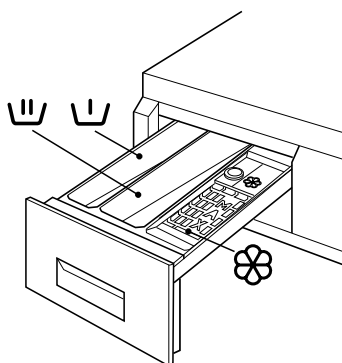
Detergent dispenser drawer



-  Compartment for prewash or soak detergent and stain remover. The prewash or soak detergent is added at the beginning of the wash programme. The stain remover is added during the STAIN-Action phase in the main wash.
-  Compartment for powder or liquid detergent used for main wash. It is emptied at the beginning of the wash cycle.
-  Compartment for liquid additives (fabric softener, starch). It is emptied at the last rinse.

The quantity of additives must not exceed the "MAX" mark in the drawer.

Before the first wash

Before your first wash, we recommend that you run a cotton cycle at 60°C, **without any laundry in the machine**, to remove any manufacturing residue from the drum and tub.

Pour 1/2 a measure of detergent into the dispenser drawer and start the machine.



Preparing the wash cycle

Sorting out and preparing the laundry

- Sort out the laundry according to type of fabrics and care labels (see "Types of fabric and care labels").
- Empty pockets.
- Remove any metal parts (safety pins, clips, etc.).
- To prevent the laundry from getting damaged and forming bundles, it is advisable to close zips, button up pillowcases and quilt covers and tie up loose straps such as those of aprons.
- Turn double faced items inside out (sleeping bags, anoraks, etc.)
- Turn coloured knitted fabrics, woollens and fabrics with trim inside out.
- Wash small and delicate items (baby socks, tights) inside a laundry net or in a pillow case closed with a zip, or in larger socks.
- Treat curtains with special care. Remove all metal or plastic hooks or put them in a net or a bag. We take no responsibility for any damage.
- Whites and coloureds must be washed separately: white items can lose their whiteness.
- New coloured fabrics often have excess dyes; it is advisable to wash them separately for the first time.
- Wash small and large items together; this improves the washing result and the laundry is better distributed during spinning.
- Shake out garments before putting them into the machine.
- Insert each garment separately.

Preparing the wash cycle

Weight of laundry

| Sort of laundry | Approximate dry weights |
|---------------------|-------------------------|
| Bathrobes | 1200 g |
| Work shirts | 300-600 g |
| Quilt covers | 700 g |
| Sheets | 500 g |
| Blouses | 100 g |
| Hand towels | 200 g |
| Tea towels | 100 g |
| Shirts | 200 g |
| Pillowcases | 200 g |
| Night-gowns/Pyjamas | 200-250 g |
| Tablecloths | 200-300 g |
| Underwear | 250 g |

Types of fabric and care labels

The labels on garments help you to select the most suitable wash programme. The laundry should be sorted out according to the type of fabric and the instructions indicated on care labels.

Temperatures indicated on labels are always maximum temperatures.

Cotton

Linen and cottons marked with this symbol can be washed at high temperatures.

Cotton

Linen and cottons marked with this symbol are colourfast and can be washed at 60°C.

Cotton

Garments marked with these symbols have delicate colours, therefore the washing temperature must not exceed these values.

Synthetics

Mixed and synthetic fabrics marked with these symbols require a gentle wash programme and they must therefore be washed using the specific programme.

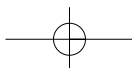

Preparing the wash cycle

Delicates  

Microfibres, synthetics or curtains marked with these symbols require a very gentle treatment.

The DELICATES programme is suitable for this type of fabric.

Woollens and particularly delicate items    

Fabrics such as wool, wool mix or silk marked with this symbol are particularly sensitive to machine washing.

The WOOLLENS programme is suitable for this type of fabric.

If the label has the symbol  (do not wash), the garments must not be machine washed!

Preparing the wash cycle

Detergents and additives

Which detergent and additive?

Use only detergents and additives for washing machines. Follow the manufacturer's instructions.

How much detergent?

The quantity depends on:

- the load:
if the manufacturer does not provide any indications on the amount of detergent for small loads, use about one third less than the suggested amount for half loads and half the amount for very small loads;
- the degree of soil:
use a small amount of detergent for lightly soiled garments. Judge the amount according to the detergent manufacturer's instructions and size of the load;
- the water hardness:
the harder the water, the more detergent required. Instructions according to water hardness are given on the detergent pack.

Liquid detergent

Liquid detergent can be poured directly into the main wash compartment of the dispenser drawer **immediately** before starting the programme, or a special dispenser can be used that is placed directly in the drum. Measure the detergent according to the manufacturer's instructions.

Adding a water softener (descaling product)



A water softener must be added when water has a medium-high degree of hardness (from degree of hardness II). Follow the manufacturer's instructions. The quantity of detergent can then always be adjusted to degree of hardness I (= soft). Information on water hardness can be obtained from your local water supply authority.

Information on water hardness



| Degree of hardness | German degrees °dH | French degrees °TH |
|--------------------|--------------------|--------------------|
| I=Soft | 0-7 | 0-15 |
| II=Medium | 7-14 | 16-25 |
| III=Hard | 14-21 | 26-37 |
| IV=Very hard | more than 21 | more than 37 |

i How to wash

Load the laundry

-  Open the door.
-  Place the laundry in the drum, one item at a time. Distribute laundry as evenly as possible. Close the door.



Add detergent and additive

-  Pull the drawer out till it stops.
-  Pour the main wash detergent into compartment .

If you wish to perform a pre-wash, a SOAK or a STAIN-Action programme, pour detergent or stain remover into compartment .

Important!

Do not use normal detergent for the STAIN-Action programme, always use a STAIN remover.

-  Pour the fabric softener into compartment  without exceeding the "MAX" mark.
-  Close the drawer gently, pushing it fully in.

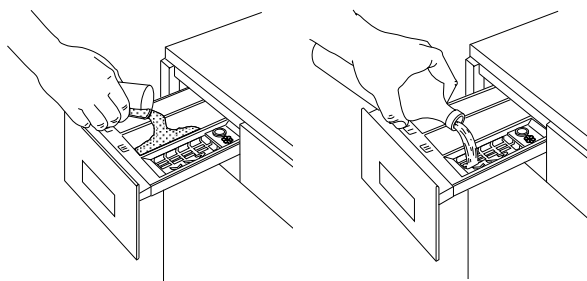

How to wash

Selection of the desired wash programme

Turn the programme selector dial to the desired position: the lights corresponding to the different phases making up the selected programme light on. The display shows the duration of the programme.

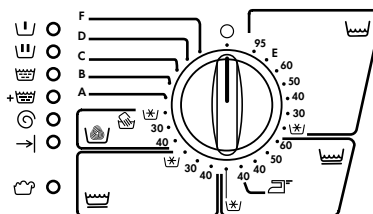

Selection of the desired options

depending on the degree of soil of the laundry. The corresponding light comes on.

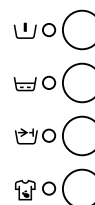



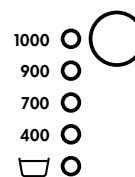

Selection of the spin speed or RINSE HOLD option

It is possible to select a lower spin speed by means of the relevant button; the light corresponding to the selected speed comes on.

Selecting option  (RINSE HOLD) the laundry is left immersed in the final rinse water.



i If the spin speed is not reduced, the final spin speed will be as follows:

- cottons  1000 r.p.m.
- synthetics  900 r.p.m.
- delicates  700 r.p.m.
- wool   (hand washing) 900 r.p.m.

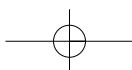

EXTRA RINSE

This appliance is designed for saving water. However, for people with a very delicate skin (allergic to detergents) it may be necessary to rinse the laundry using an extra quantity of water (extra rinse).



The extra rinse is available only with the cotton, synthetics or delicate programme.

Selection of the EXTRA RINSE option

- Press simultaneously buttons and for about 3 seconds: the light comes on in the programme progress display. This function stays permanently on. To remove it press buttons and again until the light comes off.

Selection of the DELAY START option

- To delay starting of a programme, press the DELAY START button **before starting the machine**. The figures corresponding to the selected delay will be displayed for about 3 seconds, after which the duration of the selected programme will appear on the display.

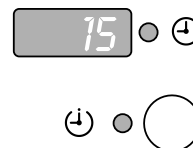

If button (SOAK) has been pressed the selected delay will correspond to the soak time. If no delay time is selected the soak programme will last about 30 minutes.

When the START/PAUSE button is pressed, the selected delay will appear again on the display and the machine starts its countdown.

How to wash

Starting the programme

1. Check that the water tap is open.
2. Press START/PAUSE to start the programme. If the Delay Start option has been selected the programme will start at the end of the count-down.

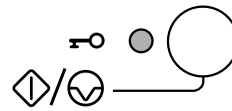







If the door light  is red and flashing at the start of the programme it indicates that the door is open. Close the door and press the START/PAUSE button again.

If the delay start option has been selected, the machine starts its countdown, in hours, which will appear on the display. During this period it is possible to load other laundry, to modify or cancel the delay time.

- **Load other laundry:** press the START/PAUSE button. Open the door. Load the laundry. Close the door and press the START/PAUSE button again.
- **Modify or cancel the delay time:** press the START/PAUSE button. Press the DELAY START button  until the time required appears on the display, or 0h, if you wish to cancel it. Press the START/PAUSE button again.

Programme progress display

By selecting the wash programme, the pilot lights corresponding to the various phases making up the programme come on. After the machine has started, only the running phase pilot light stays on.

-  ○ PREWASH
-  ○ WASH
-  ○ RINSES
-  ○ EXTRA RINSE
-  ○ SPIN
-  ○ END
-  ○ OVERDOSAGE

Display

The time to the end of the programme decreases minute by minute and appears on the display.





At the end of the programme

The machine stops automatically. A zero appears on the display. An acoustic signal is clearly audible. The END → light comes on in the programme progress display.

i If the light  (OVERDOSAGE) comes on it indicates that too much detergent has been used. At the next wash carefully follow the detergent manufacturer's instructions. Measure out detergent according to amount, type, degree of soil of fabrics and water hardness.

This light could come on also when the drain filter is blocked.

 If the RINSE HOLD  option has been selected, the water must be emptied out before opening the door either

- by pressing the START/PAUSE button (the laundry will be spun at the speed corresponding to the selected type of fabrics. The spin speed can be reduced by means of the SPIN SPEED button)
- or by turning the selector dial to  and then to DRAIN "C" and pressing the START/PAUSE button again. In this case the water will be emptied, but the laundry is not spun.

 Turn the selector dial to .

 Remove the laundry from the drum.











 Check that the drum is empty so as to avoid any forgotten items being damaged in a subsequent wash (e.g. shrinking) or their colour running into a load of whites.

 Close the water tap.

 Leave the door open to prevent the formation of mildew and unpleasant smells.

Programme chart

Wash programmes

| Wash programme | Temp. | Fabrics | Additional functions | Max. load | Consumption* | | |
|---|---|--|--|-----------|--------------|-----------|---------------|
| | | | | | Energy kWh | Water lt. | Duration min. |
| White Cottons  | 95°-60° | Cotton and linen, for example normally soiled work garments, sheets, household linen, underwear, towels. | STAIN SOAK QUICK PREWASH EXTRA RINSE RINSE HOLD SPIN SPEED | 4.5 kg | 1.6 | 46 | 151 |
| E Whites ECONOMY  | 60° | Cotton and linen, for example normally to lightly soiled sheets and household linen. | PREWASH EXTRA RINSE RINSE HOLD SPIN SPEED | 4.5 kg | 1.0 | 43 | 141 |
| Coloured cottons  | 60°-50° 40°-30° COLD  | Coloured cotton or linen fabric, shirts, underwear, towels. | STAIN SOAK QUICK PREWASH EXTRA RINSE RINSE HOLD SPIN SPEED | 4.5 kg | 0.76 | 43 | 133 |
| Synthetics  | 60°-50° 40° COLD  | Synthetic fabrics, underwear, coloured garments, non-shrink shirts, blouses. | STAIN SOAK QUICK PREWASH EXTRA RINSE RINSE HOLD SPIN SPEED | 1.5 kg | 0.65 | 50 | 92 |
| Delicates  | 40°-30° COLD  | Delicate fabrics, for example curtains. | STAIN SOAK QUICK PREWASH EXTRA RINSE RINSE HOLD SPIN SPEED | 1.5 kg | 0.40 | 50 | 64 |
| Wool   | 40°-30° COLD  | Wool, wool mixtures, silk. | RINSE HOLD SPIN SPEED | 1 kg | 0.35 | 45 | 56 |

In compliance with EC directive 92/75, the consumption figures indicated on the energy label refer to the 60°C wash programme for cotton with a load of 4 kg.

* The consumption data shown on this chart is to be considered purely indicative, as it may vary depending on the quantity and type of laundry, on the inlet water temperature and on the ambient temperature. It refers to the highest temperature for each wash programme and to a load of 4 kg of cotton items.

Programme chart



Special programmes

| Programme | Description | Programme phases | Additional functions | Max. load | Consumption* | | |
|---------------------------|--|---|---|-----------|--------------|-----------|---------------|
| | | | | | Energy kWh | Water lt. | Duration min. |
| A Gentle rinses | This programme can be used for rinsing hand washed garments. | 3 rinses with liquid additive. Short spin. (700 rpm max) | EXTRA RINSE RINSE HOLD SPIN SPEED | 4.5 kg | 0.1 | 33 | 21 |
| B Softeners | Hand washed garments to be starched or softened. | 1 rinse with liquid additive. Long spin. | RINSE HOLD SPIN SPEED | 4.5 kg | / | 14 | 23 |
| C Drain | For emptying out the last rinse water in programmes with the Rinse Hold option  | The water is emptied out. | | / | / | / | 3 |
| D Spin | Separate spin for cottons. | Long spin. | SPIN SPEED | 4.5 kg | / | / | 10 |
| F Short spin | Separate spin for synthetics and delicate fabrics. | Short spin. (700 rpm max) | SPIN SPEED | 1.5 kg | / | / | 4 |
| O Reset/Off | | For cancelling the programme which is running or to switch the machine off. | | | | | |

* The consumption data shown on this chart is to be considered purely indicative, as it may vary depending on the quantity and type of laundry, on the inlet water temperature and on the ambient temperature. It refers to a load of 4 kg for cotton items.

Cleaning and maintenance

After each wash

-  At the end of the wash programme, pull the dispenser drawer out a little to let it dry.
-  Leave the door ajar to allow air to circulate.

If the machine is not used for a prolonged period:

-  Close the water tap and unplug the appliance.

Periodical cleaning





Exterior

-  Clean the outside of the cabinet with soap and water only. Rinse with clean water and dry.

Important: do not use methylated spirits, solvents or similar products to clean the cabinet.

Detergent dispenser drawer

After a while, detergents and fabric softeners leave deposits in the drawer.

-  Clean the drawer, from time to time, by rinsing it under a running tap. To remove the drawer from the machine, press the button in the rear left-hand corner.
-  To facilitate cleaning, the top part of the additive compartment can be removed.
-  Detergent can also accumulate inside the drawer recess: clean it with an old toothbrush.
-  Refit the drawer after cleaning.

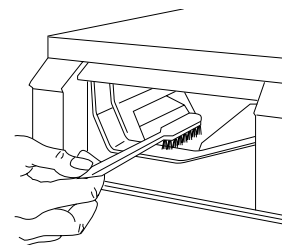
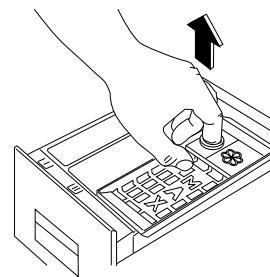
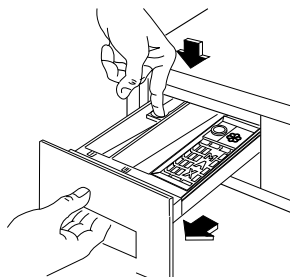



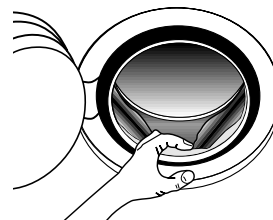

Door seal

Check from time to time the door seal and eliminate eventual possible objects that could be trapped in the fold.



Drain filter



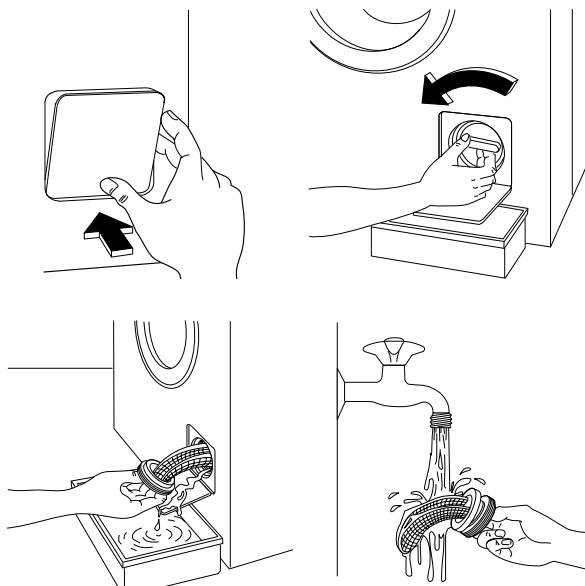

The drain filter collects threads and small objects inadvertently left in the laundry. Check regularly that the filter is clean.

-  Open the filter door.
-  Place a container under the filter and unscrew it; some water will come out of the filter.
-  Pull out the filter.
-  Clean the filter under a running tap, then refit it, screwing it fully in.



Water inlet filter

If you notice that the machine is taking longer to fill, check that the filter in the water inlet hose is not blocked.

-  Turn off the water tap.
-  Unscrew the hose from the tap.
-  Clean the filter with a stiff brush.
-  Screw the hose back onto the tap.

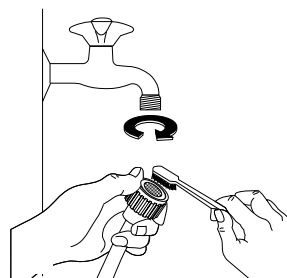

Cleaning and maintenance

Emergency emptying out

If the water is not discharged (pump is blocked, filter or drain pipe are clogged), proceed as follows to empty out the machine:

- pull out the plug from the power socket;
- close the water tap;
- if necessary, wait until the water has cooled;
- place a bowl on the floor;
- put the drain hose end into the bowl and let the water come out.

Should it not be possible to have access to the drain hose because, for example the appliance is built in the kitchen furniture, slightly loosen the drain filter after placing a bowl on the floor to let the water come out slowly.

At the end screw the filter again.

Frost precautions

If the machine is installed in a place where the temperature could drop below 0°C, proceed as follows:

- Close the water tap and unscrew the water inlet hose from the tap.
- Place the end of the drain hose and the inlet hose in a bowl placed on the floor.
- Select the "DRAIN" programme "C" and run it until the machine stops.
- Turn the programme selector dial to **O** (RESET).
- Remove the plug from the power socket.
- Screw the water inlet hose back on and put the drain hose back in its place.

By doing this, any water remaining in the machine is removed, avoiding ice forming and consequently damage to the appliance.

When you use the machine again, make sure that the ambient temperature is above 0°C.

Something not working?

i If during the spin cycle the machine makes an unusual whistling noise, different from the noise made by traditional washing machines, this is due to a new type of motor.



If water is not visible in the drum, this is due to the modern technology of new washing machines that use less water than traditional machines.

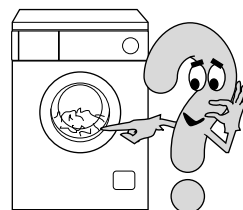



Troubleshooting

If a problem arises, you can try to solve it yourself following the instructions below.

If you call out an engineer when one of the following problems arises, or to repair a fault due to incorrect use, the call-out will be charged even if requested within the guarantee period.

During machine operation the following alarm codes may be displayed:

- **E10:** problem with the water supply (phase light  is on)
- **E20:** problem with water draining (phase light  is on)
- **E40:** door open (phase light  is on)

Once the problem has been eliminated, press the **START/PAUSE** button to restart the programme. If after all checks, the problem persists, contact your local AEG Service Force Centre.

| Problem | Possible cause | Solution |
|---------------------------|--|--|
| The machine does not work | The main electrical fuse has blown. | Replace the fuse. |
| | The door is not properly closed (E40). | Close the door; the click of the lock should be heard. |
| | The plug is not connected. | Insert the plug. |
| | The START button has not been pressed. | Press the button. |
| | The DELAY START option has been selected. | Check the selected delay on the display. |

Something not working?

| Problem | Possible cause | Solution |
|---|---|--|
| The machine does not fill | The water tap is closed (E10) . | Open the water tap. |
| | The water inlet hose is squashed or kinked (E10) . | Check the whole length of the hose and remove the kink. |
| | The small filter of the water inlet hose is clogged (E10) . | Clean the filter. |
| | The door is not properly closed (E40) . | Close the door. |
| The machine fills then empties immediately | The end of the drain hose is too low. | Place the hose at the right height (see Installation section). |
| The machine does not empty and/or does not spin | The drain hose is squashed or kinked (E20) . | Check the whole length of the hose and remove the kink. |
| | The drain filter or the drain hose are clogged (E20) . | Clean the filter or check the hose. |
| | The RINSE HOLD option <input type="checkbox"/> (stop with water in drum) has been selected. | Empty out the water by pressing the START button or selecting the DRAIN programme. |
| | The laundry is not evenly distributed inside the drum. | Redistribute the laundry manually in the drum. |
| There is water on the floor | Too much detergent has been used. | Measure detergent according to the manufacturer's instructions. |
| | An unsuitable detergent has been used that creates too much foam. | Use a suitable washing machine detergent. |
| | One of the connectors on the water inlet hose is leaking. | Check that the hose is firmly screwed on at both ends. |
| | The drain filter has not been properly screwed on after cleaning. | Fully screw the filter into place. |

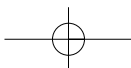

Something not working?

| Problem | Possible cause | Solution |
|---|--|---|
| The machine vibrates or is noisy | The transit bolts have not been removed. | Check that the machine has been unpacked as described in the Installation section. |
| | The feet have not been adjusted. | Carefully level the machine. |
| | There is little laundry in the drum. | Correct operation of the machine is not affected. |
| The door will not open | The programme is still running and the drum is turning. | Wait until the end of the programme before opening the door. |
| | The water level is above the bottom edge of the door. | Before opening the door, the water must be emptied out. |
| | The machine is heating the water. | Wait until the end of the heating phase. |
| Spinning starts late or the machine does not spin | The unbalance detection device that prevents excessive vibration during spinning has cut in. | <p>If the laundry is not evenly distributed inside the drum at the beginning of the spin cycle, the machine detects this and tries to redistribute it more evenly by means of a few drum rotations.</p> <p>Only when the laundry is more evenly distributed will the spin cycle be performed, at a lower speed, if the laundry is not evenly distributed.</p> <p>If, after about 10 minutes, the laundry is still tangled, the machine will not spin. Therefore, if the laundry is still wet at the end of the cycle, it is advisable to redistribute it manually inside the drum and to select the spin programme.</p> |

Something not working?

Unsatisfactory washing results

If the laundry looks grey and lime scale is found in the drum

- Too little detergent has been used.
- An unsuitable detergent has been used.
- Stubborn stains have not been treated prior to washing.
- The programme/temperature has not been correctly selected.

If grey stains remain on the laundry

- Laundry stained with ointments, grease or oil has been washed with an insufficient amount of detergent.
- The temperature selected for the wash programme was too low.
- Fabric softener - especially the concentrated type - has come into direct contact with the laundry. Wash these stains immediately and pour fabric softener carefully.

Foam is still visible even after the last rinse

- Modern detergents often produce foam, even in the last rinse. However the laundry has been completely rinsed.

White residue is left on the laundry

- This is due to insoluble components in modern detergents and is therefore not the result of insufficient rinsing. Shake or brush the laundry. In future, it may be better to turn garments inside out before washing them. Check the choice of detergent; try using liquid detergents.

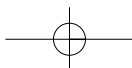

Technical data

| | |
|-------------------------------|----------------------|
| Height x Width x Depth | 84x60x45 cm |
| Depth with door opened | 82 cm |
| Height adjustment | ± 13 mm approx. |
| Load (depending on programme) | 4.5 kg max. |
| Use | domestic |
| Drum speed during washing | max. 55 rpm |
| Drum speed during spinning | 1000/900/700/400 rpm |
| Water pressure | 50-800 kPa |

- CE** This appliance complies with the following EC directives:
- 73/23/EEC of 19.2.1973 "Low voltage directive", including directive 93 / 68 / EEC
 - 89/336/EEC of 3.5.1989 "Electromagnetic Compatibility Directive".

Service

In the section "Something not working?" some problems that can be solved by yourself are listed. Read this section in the event of problems. If you are not able to find a solution, contact the Service centre. (Addresses and telephone numbers are given on the enclosed leaflet).

In all cases, explain your problem carefully, in order to facilitate troubleshooting: the engineer will be able to decide whether a service call is necessary.

Take note of the serial number (Ser.No.) and the product number (Prod. No.) indicated on the rating plate.

Ser. No.

Prod. No.

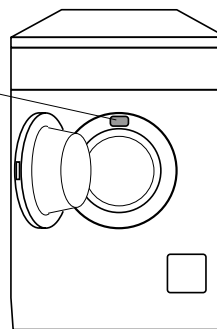
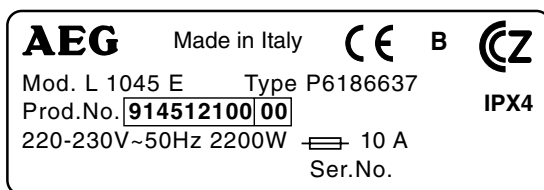

Furthermore, try to specify, as precisely as possible:

- The symptoms of the fault
- When the fault occurs
- The alarm code displayed

When can a service visit be charged during the guarantee period?

- when it should have been possible to solve the problem by yourself, with the help of the troubleshooting chart (see section "Something not working?")
- when the engineer has to come out several times because he has not been given all the relevant information he needs and so, for example, has to fetch spare parts. Repeated trips can be avoided if you prepare your call to the Service centre as described above.

Instructions for installation and electrical connection

Safety instructions for the installer

- This appliance is heavy, care should be taken when moving it.
- When unpacking the appliance, check that it is not damaged. If in doubt, do not use it and contact the retailer.
- All internal packing must be removed before using the appliance. Serious damage may be caused to the machine or adjacent furniture if the protective transit devices are not completely removed. Refer to the relevant paragraph.
- Any electrical work required to install this appliance must be carried out by a qualified electrician.
- Any plumbing work required to install this appliance must be carried out by a qualified plumber.
- After having installed the machine, check that it is not standing on its electrical supply cable.
- If the appliance is placed on a carpeted floor, ensure that air can circulate freely between the adjustable feet and the floor.
- The installation should comply with local water authority and building regulations requirements.
- Should the appliance power supply cable need to be replaced, this should be carried out by our Service Centre.

Dimensions of the appliance

Front view and side view

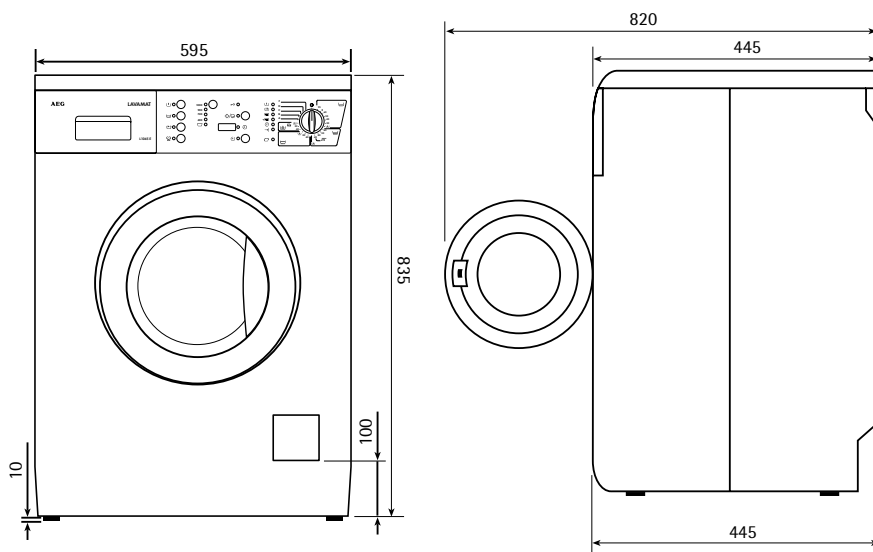

Rear view

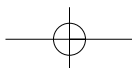
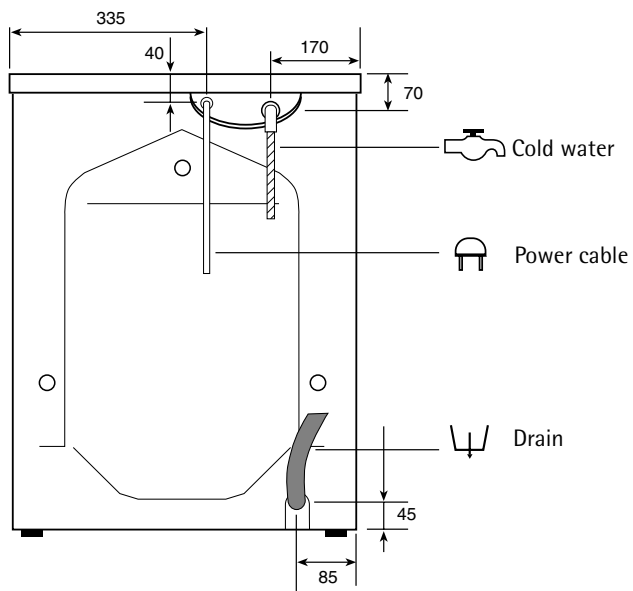

Installation

Unpacking

⚠ All transit bolts and packing must be removed before using the appliance.

👉 Using a spanner, unscrew and remove the rear right-hand bolt and lay the machine on its back, taking care not to squash the hoses. This can be avoided by placing one of the corner packing pieces between the machine and the floor.

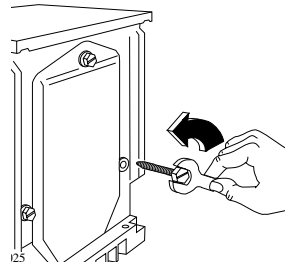

👉 Remove the polystyrene block from the bottom of the machine and release the two plastic bags which are fixed under the filter door.

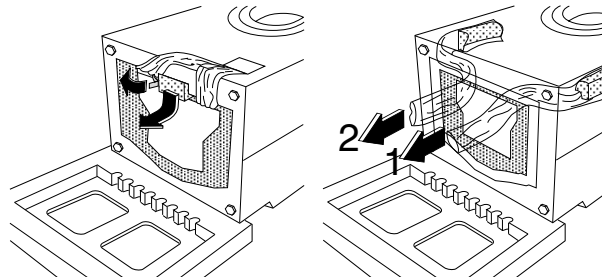

👉 Carefully remove the right-hand bag (1) then the left-hand bag (2) by pulling them towards the centre of the machine.

👉 Set the machine upright and remove the two remaining bolts from the back.

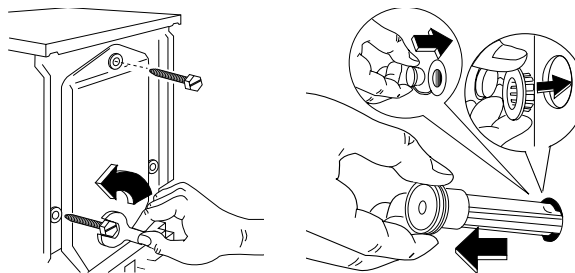

👉 Pull out the three plastic spacers from the holes into which the bolts were fitted.

👉 Plug the open holes with the plugs which you will find in the plastic bag containing the instruction booklet.

You are advised to keep all transit devices so that they can be refitted if the machine ever has to be transported again.

Installation

Positioning

Install the machine on a flat hard floor.

Make sure that air circulation around the machine is not impeded by carpets, rugs etc.

- Before placing it on small tiles, apply a rubber coating.
- Never try to correct any unevenness in the floor by putting pieces of wood, cardboard or similar materials under the machine.
- If it is impossible to avoid positioning the machine next to a gas cooker or coal-burning stove, an insulating panel (85x57 cm) covered with aluminium foil on the side facing the cooker or stove, must be inserted between the two appliances;
- The machine must not be installed in rooms where the temperature can drop below 0.
- The water inlet hose and the drain hose must not be kinked.
- Please ensure that when the appliance is installed, it is easily accessible for the engineer in the event of a breakdown.

Levelling

Carefully level by screwing the adjustable feet in or out. Never place cardboard, wood or similar materials under the machine to compensate for any unevenness in the floor.

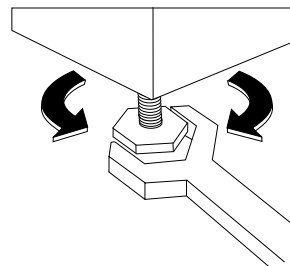

Water inlet

Connect the water inlet hose supplied with the machine to a separate tap with a 3/4" thread. **Do not use already employed hoses.**

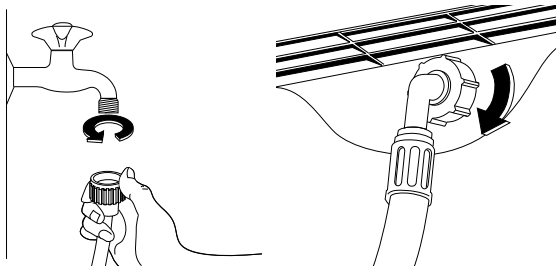

The other end of the inlet hose which connects to the machine can be turned in any direction. Simply loosen the fitting, rotate the hose and retighten the fitting, making sure there are no water leaks.

The inlet hose must not be lengthened. If it is too short and you do not wish to move the tap, you will have to purchase a new, longer hose specially designed for this type of use.

Water drainage

The end of the drain hose can be positioned in three ways:

Hooked over the edge of a sink using the plastic hose guide supplied with the machine. In this case, make sure the end cannot come unhooked when the machine is emptying.

This could be done by tying it to the tap with a piece of string or attaching it to the wall.

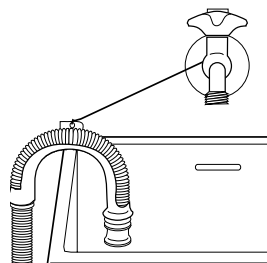

In a sink drain pipe branch. This branch must be above the trap so that the bend is at least 60 cm above the ground.

Directly into a drain pipe at a height of not less than 60 cm and not more than 90 cm.

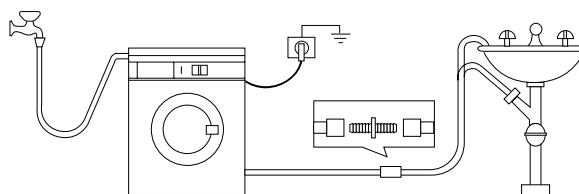

The end of the drain hose must always be **ventilated**, i.e. the inside diameter of the drain pipe must be larger than the outside diameter of the drain hose.

The drain hose must not be kinked. Run it along the floor; only the part near the drainage point must be raised.

Electrical connection

This machine is designed to operate on a 220-230 V, single-phase, 50 Hz supply.

Check that your domestic electrical installation can take the maximum load required (2.2 kW), also taking into account any other appliances in use.

Connect the machine to an earthed socket.



The manufacturer does not accept any responsibility for damage or injury through failure to comply with the above safety precaution.

Installation

Permanent connection

In the case of a permanent connection it is necessary that you install a double pole switch between the appliance and the electricity supply (mains), with a minimum gap of 3 mm between the switch contacts and of a type suitable for the required load in compliance with the current electrical regulations.

The switch must not break the yellow and green earth cable at any point.

This operation must be performed by a qualified electrician.

Important: The power supply cable must be easily accessible after installing the machine.

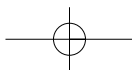
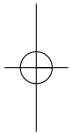
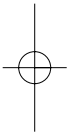

AEG Hausgeräte GmbH
Postfach 1036
D-90327 Nürnberg

<http://www.aeg.hausgeraete.de>

© Copyright by AEG

132.996.650-01-0901

