



REGGALTM

Automatic Breadmaker

Model No. K6772

K6772

FOR
HOUSEHOLD
USE ONLY



REGGALTM
Automatic Breadmaker

100%
MINI-START
START
STOP

REGGALTM
Automatic Breadmaker

Guide and Cookbook

K6772

INTRODUCTION

This book is both a guide and a cookbook for your new Regal Automatic Breadmaker. An outgrowth of extensive research on breadmaking, let it guide you to becoming a successful, confident bread baker.

To make effective use of this book, first read over the pages on safety precautions and construction of the breadmaker. Everything is clearly illustrated for you with diagrams and illustrations.

Then move on to the sections on breadmaking. We've included some helpful suggestions on breadmaking in general as well as detailed explanations of how to use the three bread settings on your new Regal appliance.

Our recipes have been developed in the Regal kitchens and tested for accuracy, taste and appearance. We know the tantalizing aroma of fresh, homemade bread—baked with the ease of your automatic breadmaker—will inspire you to bake bread often!

Parts and Functions

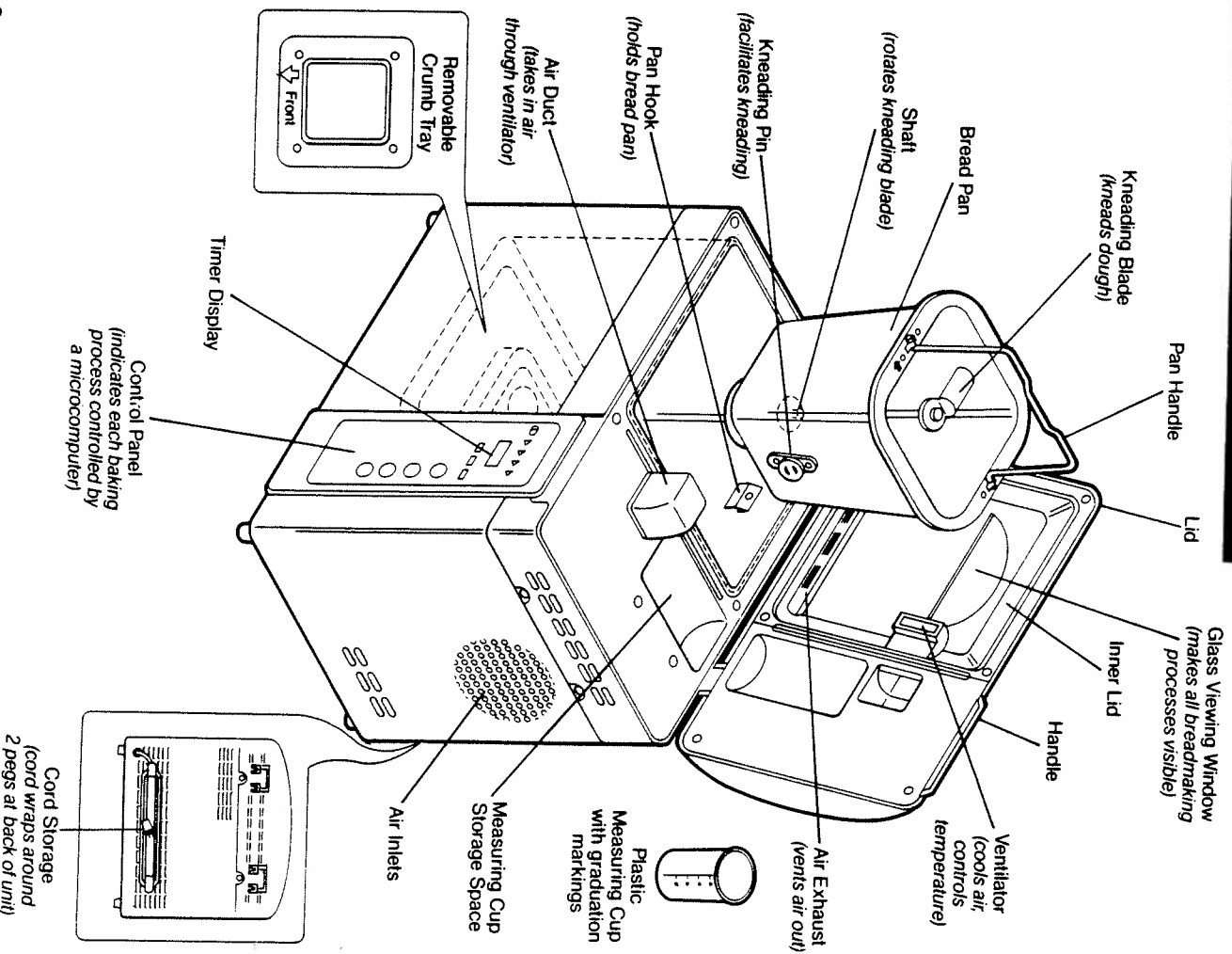

REUBEN BAKE

Dough Setting

- 1/2 cup + 2 tablespoons water
- 2 tablespoons oil
- 1 tablespoon molasses
- 1 cup rye flour
- 1 cup bread flour
- 2 teaspoons caraway seed
- 2 teaspoons instant minced onion
- 1/4 teaspoon salt
- 2 teaspoons dry active yeast

Follow instructions for Dough Setting. Press dough into greased 9-inch round cake pan.

Topping

- 1/4 cup mayonnaise
- 1 1/2 tablespoons prepared mustard
- 2 teaspoons prepared horseradish
- 1 package (2 1/2 ounces) corned beef, chopped
- 1 can (8 ounces) sauerkraut, well drained
- 1 cup (4 ounces) shredded Swiss cheese

In small bowl, combine mayonnaise, mustard, horseradish, spread over dough. Cover with waxed paper and let rest 30 minutes. Preheat oven to 350° F. Layer corned beef and sauerkraut on dough. Top with cheese. Bake 30-35 minutes. 4-5 servings.

CRUSTY FRENCH BREAD

Dough Setting

- 1 1/4 cups water
- 3 cups bread flour
- 1 1/2 teaspoons salt
- 2 teaspoons dry active yeast
- Commeal
- Poppy or sesame seeds, optional

Measure all ingredients into bread pan except commeal and seeds. Follow instructions for Dough Setting.

Roll or pat dough into a 12 x 16-inch rectangle. Starting with the 16-inch side, roll up tightly. Pinch ends and edges to seal. Place on a greased baking sheet sprinkled with commeal. Cover, let rise in warm place until almost doubled, about 1 hour. With a sharp knife make 6 diagonal slashes across the top. Spray or brush with water. Sprinkle with poppy or sesame seeds, if desired. Bake in preheated 425° F. oven for 25-30 minutes or until golden brown. Remove and cool on rack.

Makes 1 loaf.

Caution for Use and Safety

Appliance Problems

■ If breadmaker does not come on:

- Main circuit breaker is tripped.
- One of the house fuses has blown.
- The plug isn't fully inserted into the wall receptacle.
- Bread pan isn't properly positioned inside the unit.

■ If breadmaker is accidentally unplugged during operation:

- Power supply is off for less than 5 minutes, plug in and operation will continue.
- Power supply is off longer than 5 minutes, start again with new ingredients.

■ If mixing blade comes out with the bread:

- Since mixing blade is detachable, this can happen. Remove it with a non-metallic utensil. Caution: The mixing blade will be hot.

■ If flour or water leaks from the bread pan:

- Be sure kneading pin is installed in bread pan. If not, insert pin and start again.

■ If smoke is emitted during operation:

- Ingredients have spilled on the heating element or in oven area. Unplug unit; remove bread pan. Wipe out spillover, crumbs or dust and start again. Caution: The oven cavity and heating element may be hot.

Timer Problems

■ Timer cannot be used to delay baking on RAISIN BREAD setting:

- Because you have to lift the lid and add extra ingredients during the kneading process, the timer cannot be used.
- Eggs, fresh milk, cream and cottage cheese are not recommended when using the timer because they may spoil in the bread pan when delaying baking time.

■ Timer cannot be used to delay baking on the DOUGH setting:

- Breadmaker cannot shape individual rolls, doughnuts, etc. Dough should be removed after 1 hour and 25 minutes, when the unit beeps 8 times (eight beeps).

■ Timer cannot be used for less than 3:40 or more than 13 hours:

- A complete cycle takes 3 hours and 30 minutes. Longer baking times could alter baking results.

Do not use breadmaker on a surface not resistant to heat, or where it is exposed to direct sunlight.

Place the breadmaker to allow for 4 inches of clearance on all sides.

Plug it into a properly wired wall outlet (120 volts AC only).

Keep the breadmaker away from babies and children. They may touch the control buttons and the breadmaker cover and glass window are hot during operation.

Do not cover the breadmaker with anything during operation as this may cause a malfunction.

Do not open the lid or remove the bread during operation. The lid may be opened on the Raisin Bread setting to add extra ingredients at the indicated time. Extra water or extra flour may be added during the Knead cycle if dough appears too dry or too moist.

Do not touch cover or glass window of breadmaker during operation. They will be hot.

Do not dent or damage the bread pan. The breadmaker will not operate properly.

Do not immerse the bread pan in water or wash it in a dishwasher. This could cause malfunction of the shaft or rusting. Wipe pan with a damp cloth to clean.

Do not immerse the breadmaker, cord or plug in water at any time. This could cause shock or malfunction.

Before Using Your Breadmaker

IMPORTANT SAFEGUARDS

When using electrical appliances, follow the basic safety precautions advised, such as:

1. READ ALL INSTRUCTIONS.
2. To protect against electrical hazards, do not immerse cord, plug or appliance in water or other liquids.
3. Do not touch hot surfaces. Use handles or knobs. Always use pot holders or oven mitts to handle hot bread pan or hot bread.
4. Close supervision is necessary when any appliance is used by or near children.
5. Unplug from outlet when not in use and before cleaning. Allow to cool before putting on or taking off parts.
6. Avoid contacting moving parts.
7. Do not operate appliance with a damaged cord or plug or after appliance has malfunctioned, or is dropped or damaged in any manner.
8. Do not use attachments not recommended or sold by the appliance manufacturer. This may cause fire, electrical shock or injury.
9. Do not use outdoors.
10. Do not let cord hang over edge of table or counter, or touch hot surfaces.
11. Do not place appliance on or near a hot gas or electric burner, or in a heated oven.
12. To disconnect, grip plug and pull from wall outlet. Never pull on the cord.
13. Do not use appliance for other than its intended use.
14. This product is intended for household use only.

SAVE THESE INSTRUCTIONS

NOTICE: A short cord is provided to reduce the risks of becoming tangled in or tripping over a longer cord. Extension cords may be used if care is exercised in their use and the wattage rating is at least as great as the wattage stamped on the base of the appliance. If an extension cord is used, it should be arranged so that it will not drape over the counter or tabletop where it can be reached by children or tripped over accidentally.

Bread Problems

■ **Dough consistency is important; check while it is mixing. If dough is dry rather than pliable, add water, 1 tablespoon at a time. When dough is too dry it does not rise properly. This occurs more often in dry winter months. When humidity is high, you may need to add flour or reduce liquid.**

■ **If height and shape of bread differ with each use:**
— This is normal. Room temperature, length of timer cycle and accuracy in measuring ingredients affect the end product.

■ **If bread has unusual odor:**
— Use fresh ingredients.
— Stale ingredients affect the aroma of bread.
— Measure accurately. Too much yeast affects the aroma.

■ **If bread is floured-looking:**
— Brush flour off corners. Not enough water was used.
— If bread top is floured, be sure kneading pin was installed in bread pan.

■ **If bread is underbaked:**
— Be sure lid was closed during operation.
— Be careful not to press the STOP button before the unit signals the bread is completed.

■ **If bread is overbaked:**
— Measure ingredients accurately. Too much sugar causes a darker crust.

■ **If bread loaf is too short, poorly shaped or coarse:**
— Measure ingredients accurately. Not enough flour, yeast, sugar or water produces these effects.

■ **If bread falls before or during baking:**
— **Next time:**
a. Either add more flour, 1 tablespoon at a time, or reduce water. Bread falls when dough is too moist.

b. Use bread flour, not all-purpose flour. Bread flour is designed specifically for yeast breads. Because of its higher protein content, it produces a stronger texture.

■ **If bread slices unevenly and is sticky:**
— Cool bread longer before slicing. Hot bread contains steam.
— Always slice bread with a sharp knife, using a sawing motion, never exert pressure on knife.
— Try using an electric knife for more even slicing.

■ **If bread top is over-inflated and browned:**
— Measure ingredients accurately. Too much flour, yeast or sugar produces this effect.

■ **If bread top is flat or concave:**
— Measure ingredients accurately. Too little flour, water or yeast produces this effect.

■ **If bread sides are damp:**
— Bread was in the bread pan too long. Remove bread when unit signals.

Recipe Conversion Problems

■ **Recipes cannot be doubled in the breadmaker:**
— Bread will swell out of the bread pan with larger proportions.

■ **Fresh milk, eggs, cottage cheese, sour cream and cream are not recommended for delayed baking with timer:**
— Fresh milk can be substituted for dry milk and the water in recipes baked immediately.
— If using timer to delay baking, fresh milk, eggs, sour cream, etc., may spoil while setting in the bread pan.

CONTENTS

	Page	Page	
Before using your Breadmaker	4	... Oat Wheat	19
... Important Safeguards	4	... Egg	20
... Caution for Use and Safety	5	... Whole Wheat	20
Introducing the Regal Breadmaker	6	... Sweet Bread	20
... Parts and Functions	7	... Potato	20
... Control Panel	7	Using the automatic Raisin Bread setting	21-22
... Display Indications	8	... A step by step guide	21-22
... Timer	9	Recipes	23
How to Clean	10	... Raisin	23
... Parts and Functions	10	... Savory Italian	23
... Storing the Breadmaker	10	... Dried Fruit	23
Tips for Breadmakers	11	... Wheat and Seed	23
... Breadmaking Terms	11	... Chocolate Nut	24
... Hints for Baking Delicious Breads	11	... Cheesy Egg	24
... Ingredients Used for Baking Bread	11	Using the automatic Dough setting	25-26
... Tips for Measuring Using Standard Measures	12	... A step by step guide	25-26
... Recipe Conversions	12	Shaping Variations	26
... High Altitude Adjustments	12	Crust Treatments	27
Automatic Breadmaking – As Easy As 1-2-3!	13	Powdered Sugar Glaze	27
Three Basic Bread Settings	13	Recipes	28
About Ingredients	14	... Pizza Crust	28
... Rising	15	... Whole Wheat Pizza Crust	28
... Freezing	15	... Overnight Caramel Rolls	29
... Storing	15	... Bread Pretzels	29
Using the automatic Bread setting	16-17	... All Purpose Butter Rolls	29
... A step by step guide	16-17	... Addie's Coffee Cake	30
Recipes	18	... Honey & Wheat Rolls	30
... White	18	... Petite Bread	30
... Oat Bran	18	... Bran Buns	30
... Rye	18	... English Muffins	30
... Oatmeal	18	... Reuben Bake	31
... Whole Wheat Cornmeal	19	... Crusty French Bread	31
... Deluxe White	19	Common Problems & Simple Solutions	32-33
... Cinnamon	19	Notes	34
		Service and Warranty Information	35

Display Indications

START button is pressed and display window reads HI

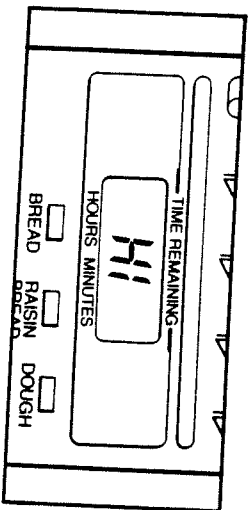

This means the oven area is hot (above 105° F./40° C.). This may occur during continuous use. Remove pan; let cool with the cover open for 5 minutes, or longer, depending on the temperature. When the oven area has cooled, to reset, press the START button.

START button is pressed and the process indicator lights flash.

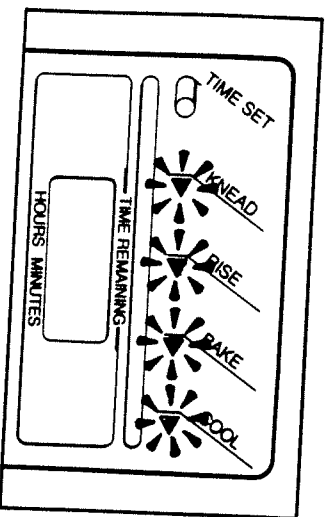

This means the bread pan has not been positioned or inserted correctly. Insert the bread pan correctly and then press the START button again.

During a Power Outage

During a power outage or other interruption in the power supply (cord unplugged or a household fuse or breaker has malfunctioned):

If the interruption in power supply is momentary (under 5 minutes) longer, the unit will not resume operation. If the interruption is 5 minutes or over, use new ingredients when you cannot determine how long the power has been off, because of potential spoilage.

BREAD PRETZELS

Dough Setting

- ¾ cup water
- 2 cups bread flour
- ½ teaspoon sugar
- ¼ teaspoon salt
- 1½ teaspoons dry active yeast
- 1 egg, beaten
- Coarse salt

Measure all ingredients into bread pan except egg and coarse salt. Follow instructions for Dough Setting.

Divide dough into 12 pieces. Roll each into an 8-inch rope. Form into pretzel shape or leave in stick shape.

Place on a greased cookie sheet, brush each with egg. Sprinkle with coarse salt. Bake in preheated 450° F. oven, for 12-15 minutes.

Makes 12 pretzels.

ALL PURPOSE BUTTER ROLLS

Dough Setting

- ¾ cup milk
- ¼ cup water
- ¼ cup butter
- 1 egg
- 2¾ cups bread flour
- 2 tablespoons sugar
- 1 teaspoon salt
- 2 teaspoons dry active yeast

Follow instructions for Dough Setting. Shape as desired.

Makes 12 rolls.

ADDIE'S COFFEE CAKE

Dough Setting

- 1 recipe SWEET BREAD (page 20)
- Omit egg white, use only egg yolk.
- Follow instructions for Dough Setting.
- Press into greased 9-inch round or 5x7-inch cake pan.

Topping

- ¼ cup butter, melted
- ½ cup sugar
- 1 teaspoon cinnamon
- ½ cup chopped pecans
- Powdered Sugar Glaze (page 27)

Drizzle butter over dough. In small bowl, mix sugar, cinnamon and nuts, sprinkle over butter. Cover, let rise in warm place, about 30 minutes. Bake in preheated 375° F. oven for 20-25 minutes, until golden brown. Cool 10 minutes in pan on rack. Drizzle with powdered sugar glaze.

Serves 12

Control Panel

HONEY AND WHEAT ROLLS

Dough Setting

- 1 cup water
- 1/4 cup honey
- 1 egg
- 2 cups bread flour
- 1 cup whole wheat flour
- 1 teaspoon salt
- 2 teaspoons dry active yeast

Follow instructions for Dough Setting.
Shape as desired.

Makes 12 rolls.

BRAN BUNS

Dough Setting

- 1/4 cup water
- 1/4 cup butter or margarine, softened
- 1 egg
- 2 1/2 cups bread flour
- 3 tablespoons sugar
- 3/4 teaspoon salt
- 2 1/4 teaspoons dry active yeast

Follow instructions for Dough Setting.
Shape as desired.

Makes 12 buns or 24 dinner rolls.

PETITE BREAD

Dough Setting

- 1 cup water
- 1 tablespoon butter or margarine, softened
- 2 1/4 cups bread flour
- 3 tablespoons sugar
- 1 tablespoon dry milk solids
- 1 teaspoon salt
- 1 1/2 teaspoons dry active yeast
- 1 egg, beaten

Measure all ingredients, except egg into the bread pan. Follow instructions for Dough Setting.

Divide dough into 6 pieces. Let rest 20 minutes. Shape into 3 x 1 1/2-inch oblong loaves. Place on greased baking pan, spacing 1 1/2 inches apart. With sharp knife make 2 horizontal cuts across the top of each. Cover, let rise until almost doubled, about 1 hour. Brush with beaten egg. Bake in preheated 350° F. oven 10-15 minutes, until golden brown. Remove from pan; cool on wire rack.

Makes 6 mini loaves.

ENGLISH MUFFINS

Dough Setting

- 1 cup water
- 2 tablespoons butter or margarine, softened
- 2 1/4 cups bread flour
- 1/4 cup dry milk
- 1/4 cup wheat germ
- 1/4 cup quick cook oats
- 2 tablespoons sugar
- 1 teaspoon salt
- 2 teaspoons dry active yeast
- 1/4 cup cornmeal

Measure all ingredients into the bread pan, except cornmeal. Follow instructions for Dough Setting.

Sprinkle cornmeal over flat surface. Roll dough to 1/4-inch thickness. Cut into 2 1/2 to 3-inch circles. Place dough cornmeal-side-down, on ungreased baking sheets. Cover and let rise in a warm, draft-free place for 30 minutes. Preheat electric griddle or fry pan to 250° F. Cook, cornmeal side down for about 8 minutes or until golden brown. Turn and cook another 8 minutes.

Makes 10-12 3-inch muffins.

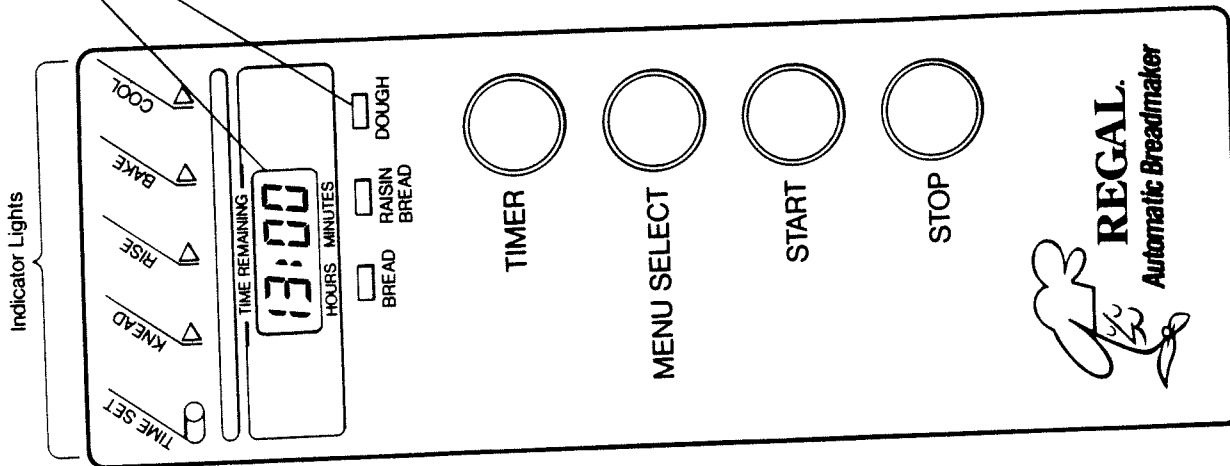

TIMER

Press this button to set the timer. Note: Timer will advance at 10 minute intervals from 4 to 13 hours. If constant pressure is applied to button, timer will change rapidly. THE TIMER CANNOT BE USED FOR THE RAISIN BREAD SETTING OR THE DOUGH SETTING.

MENU SELECT

Push this button to select the desired cycle: BREAD, RAISIN BREAD OR DOUGH. The bread maker is preset to the BREAD setting when start button is pushed. Push MENU SELECT to advance to the next menu.

START

Press this button to start operation or begin the timer. If the timer was not set, pressing this button will start the selected operation.

STOP

Press this button and hold a few seconds to cancel all operations. Remaining time window lights (0:00) will remain on as long as the unit is plugged in.

If you should make a mistake setting the timer and have already pushed the START button, just press this button for a moment to cancel the program.

How to Clean

Before cleaning the unit, unplugging and allow to cool.

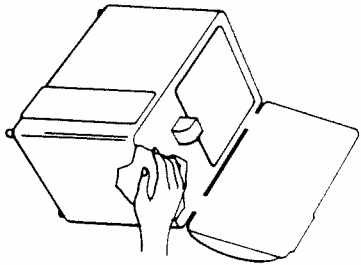

Body, lid and inner lid should be wiped clean with a damp cloth. Do not immerse in water or splash with water, as this may cause malfunction or electrical shock.

Use only mild, liquid detergent. Do not use cleansers, steel wool pads, or other abrasive materials. Also do not use benzine, thinner, alcohol, etc. Do not wash removable parts in a dishwasher.

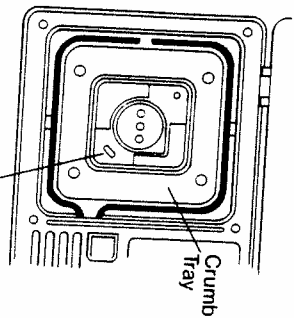

Be sure that the oven area is always kept clean. After using, wipe out crumbs or flour in oven area with a damp dishcloth. Crumb Tray.

If crumbs have accumulated, remove the crumb tray from the body and wash in sink.

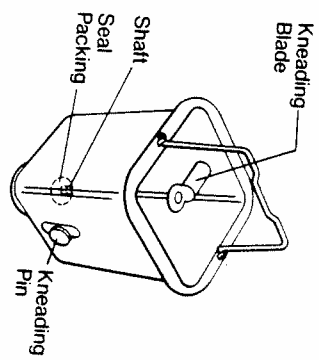

1. Wash the shaft of the bread pan with a soft cloth or sponge to prevent damage to the seal packing. Let it dry before storing bread pan inside breadmaker.
2. Clean the slot for the kneading pin by using a non-metallic material such as a toothpick or wooden skewer.
3. Wash the kneading blade and pin with a soft cloth, sponge or soft brush.
4. Do not use metal utensils with this appliance.
5. Wipe clean after each use.

NOTE: The nonstick coating may change color after long use. This is caused by moisture and steam, and has no effect on the performance or hygiene of the breadmaker.

Tips for Breadmakers

- Be sure the body has cooled completely before storing.
- Be sure that all moisture inside the unit has dried completely, before storing with the lid closed.
- Be sure to close lid.
- Do not place heavy objects on the lid as this may damage the seal.

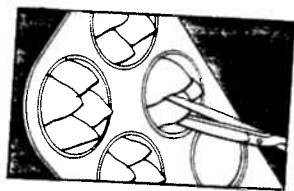

Shortcut Cloverleaves

Lightly grease 12 muffin cups. Divide dough into 12 pieces. Shape each piece into a ball, pulling edges under to make a smooth top. Place one ball in each greased muffin cup. Using scissors dipped in flour, snip top in half, then snip again crosswise, making 4 points. Let rise and bake as directed.

Makes 12



Simple Pan Rolls

Lightly grease 8 x 1 1/2-inch or 9 x 1 1/2-inch round baking pan. Divide dough into 12 pieces. Shape each into a ball, pulling edges under to make a smooth top. Place balls smooth-side-up in prepared pan. Let rise and bake as directed.

Makes 12



Butterhorns

Lightly grease baking sheet. On lightly floured surface, roll dough into a 12-inch circle. Brush with melted butter. Cut into 12 wedges. To shape rolls, begin at wide end of wedge and roll toward point. Place point down, 2-3 inches apart, on prepared baking sheet. Let rise; bake as directed.

Makes 12

Hint: To reheat yeast rolls, place in a clean brown paper bag. Sprinkle bag with water and fold the opening closed. Warm the rolls in a 325° F. oven about 10 minutes or until heated through. You may also wrap and heat the rolls in foil. Sprinkle rolls with water before wrapping.

Crust Treatments

(use only with Dough Setting)

Directions: Allow optimum rising of shaped dough. Then use pastry or leather brush to gently apply glaze. Bake as directed in recipe.

- For a shiny golden crust, use Egg Glaze or Egg Yolk Glaze.
- For a shiny chewy crust, use Egg White Glaze. **NOTE:** Because yolk is not used, crust color will not be as golden in color.

Egg Glaze

Mix 1 slightly beaten egg with 1 tablespoon water or milk.

Egg Yolk Glaze

Mix 1 slightly beaten egg yolk with 1 tablespoon water or milk.

Egg White Glaze

Mix 1 slightly beaten egg white with 1 tablespoon water.

NOTE: To keep unused egg yolk fresh for several days, cover with cold water and store in refrigerator in a covered container.

Glaze for Coffee Cakes and Sweet Rolls

- 1 cup sifted powdered sugar
 - 1 teaspoon butter or margarine, softened
 - 1 or 2 tablespoons water or milk
 - 1/2 teaspoon vanilla
- In small bowl, blend ingredients until smooth. Spread on slightly warm coffee cake or rolls.

PIZZA CRUST

Dough Setting

Whole Wheat

- 1 cup water
- 1 tablespoon olive oil or vegetable oil
- 1 tablespoon honey
- 2¼ cups whole wheat flour
- ¼ cup wheat germ
- ¾ teaspoon salt
- 2¼ teaspoons dry active yeast

Regular (white flour)

- ¾ cup water
- 1 tablespoon butter
- 2 cups bread flour
- 2 tablespoons sugar
- 1 tablespoon dry milk solids
- 1 teaspoon salt
- 1½ teaspoons dry active yeast

Make only one crust at a time.

Follow instructions for Dough Setting. Pat dough into a 9 x 13-inch greased baking pan or a greased 12-inch pizza pan. Cover, let rest 10 minutes in a warm, draft-free place.

Pizza Toppings

- 1 cup (8 ounces) prepared pizza sauce
- 1 package (3-4 ounces) sliced pepperoni
- or
- ½ lb. bulk pork sausage or ground beef, cooked and drained
- 1 can (4 ounces) mushroom stems and pieces, drained
- ¼ cup diced green pepper
- 1 cup (4 ounces) shredded Mozzarella cheese
- ¼ cup grated Parmesan cheese

Preheat oven to 400° F. Spread pizza sauce over dough. Sprinkle toppings over sauce in the sequence listed. Bake 15-20 minutes, or until crust is golden brown.

OVERNIGHT CARAMEL ROLLS

Dough Setting

- 1 recipe SWEET BREAD (page 20)

Follow instructions for Dough Setting.

- ½ cup butter
- ½ cup packed brown sugar
- 1 cup chopped pecans
- 1 package (5¾ ounces) butterscotch pudding (not instant)

Divide dough into 16 balls. Let rest 10 minutes. Meanwhile, melt butter and brown sugar in small sauce pan over medium heat. Cool 5 minutes. Sprinkle nuts into greased 10-12-cup tube pan. Empty dry pudding into small, shallow bowl. Roll each dough ball in pudding. Arrange in pan over nuts. Sprinkle remaining pudding over rolls. Drizzle cooled butter and sugar mixture over rolls. Cover with waxed paper. Refrigerate overnight.

Remove from refrigerator. Heat oven to 200° F. and turn off. Remove waxed paper; cover rolls with a clean cloth. Place in warm oven, for 30-35 minutes until almost doubled in size. Remove from oven and preheat oven to 325° F. Bake 30-35 minutes. Remove and let stand a few minutes before inverting onto serving plate.

Makes 16 rolls.

Timer

Use the timer for delayed baking with the BREAD setting only. The timer may be preset up to 13 hours before you want the bread to be done. The timer will advance in 10 minute intervals from 4 to 13 hours.

Example: If the present time is 9:00 p.m., and you want the bread to be finished at 6:30 a.m. tomorrow, set the timer to 9:30 (9 hours and 30 minutes)—the difference between the two times.

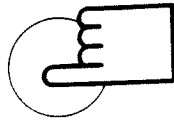

Timer

When pressed once, the timer will advance 10 minutes.

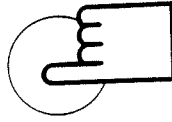

Timer

When constant pressure is applied to the button, the time will advance quickly.

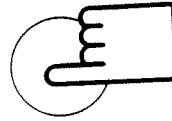

Start

Press the START button and the timer is set. The time set light goes on and dots on the display window blink.

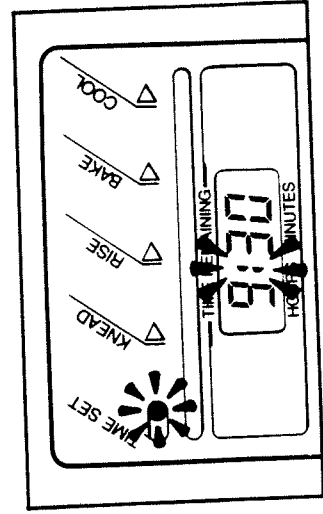

TIPS FOR MEASURING USING Standard Measures

Dry ingredients... spoon into standard dry measuring cup until overflowing. Level off with straight-edged spatula.

Sugar, shortening... press firmly into standard dry measuring cup, or measuring spoon level off.

Baking powder, baking soda, salt, spices, dry milk... fill standard measuring spoon to overflowing. Level off.

Liquid ingredients... place standard liquid measuring cup (8 fluid ounces) on level surface. Fill to specified mark and check measurement at eye level. Use standard measuring spoons for small amounts. NOTE: 4 tablespoons = 1/2 cup.

Recipe Conversions

All of your old family favorites as well as your new bread recipes can be prepared in the Regal Automatic Breadmaker. Recipe conversions are simple if you remember a few tips:

- 1 If your recipe yields two conventional loaves, cut the recipe in half. The breadmaker only makes one loaf at a time.
- 2 Never exceed a total of 3 cups of dry flour, too much wheat germ or other grains. Adding oat bran or rye flours (grains not containing gluten) will inhibit the rising of the bread. In using the DOUGH setting, the minimum total of 4 cups) because the rising and baking is done outside the unit.
- 3 Always measure water or liquid shortening, eggs, liquid sweeteners first. Then measure the dry ingredients into your breadmaker. Carefully place dry yeast on top of dry ingredients.
- 4 Do not mix in any nuts, dried fruits, cheese or other ingredients that would normally be kneaded into the dough. This must be done 5 minutes before the end of the knead cycle on the RAISIN BREAD setting. An audible signal indicates the correct moment.
- 5 1 tablespoon dry milk = 1/2 cup fresh milk. Reduce the amount of water in proportion to the amount of fresh milk added. Fresh milk, cream, eggs, sour cream, etc. are not recommended when using the timer to delay the start of the kneading, rising and baking processes.

the crust brown and the bread soft. Brown sugar, honey molasses or syrups produced from maple, corn or cane are also suitable sweeteners; adding vitamin B and minerals.

Milk
Milk enhances flavor and increases the nutritional value of the bread but it is not a necessary ingredient. Other liquid may be substituted (see below "Water or Other Liquids").

Salt
Salt controls the action of the yeast, enhances flavor and aids in producing a firm dough.

Fats
Any form of shortening will enrich flavor and produce a more tender, flakier dough.

Butter
Butter adds flavor. A vegetable shortening or oil in the same amount may be substituted. Salted or unsalted butter may be used in breadmaking.

Oil
Vegetable, corn, peanut, safflower, soy or sunflower oil can be used. Unsaturated safflower oil may be used in some special health breads. Olive oil is often used in pizza dough to tenderize and flavor the dough. Walnut oil is delicious in walnut bread and peanut oil keeps bread fresher longer.

Margarine
This is an acceptable substitute for butter.

Vegetable Shortening
This solid, white shortening gives a slightly crispier texture than other fats but works effectively.

Water or Other Liquid
When the flour is mixed with water or another liquid, gluten is formed and air is trapped, thus allowing the bread to rise. Flour can be mixed with water, milk, beer, fruit juices or purees.

Important: If loaf falls while baking, too much liquid was used. If loaf is small, heavy and a dense, moist texture, too little was used. You can adjust the liquid or flour 1 tablespoon at a time, in the first 25 minutes of the cycle.

High Altitude Adjustments

At altitudes above 3,000 feet, flour tends to be drier and absorbs less liquid. Slightly more liquid or less flour may be required.

Dough rises faster at higher altitudes. Either sugar or yeast should be reduced slightly to prevent over-rising.

See Table for guidelines:

ADJUSTMENT	3,000 ft.	5,000 ft.	7,000 ft.
Reducing yeast: For each teaspoon, decrease	1/2 tsp.	1/2 - 1/4 tsp.	1/4 tsp.
Reducing sugar: For each cup, decrease	0-1 tbsp.	0-2 tbsp.	1-3 tbsp.
Increasing liquid: For each cup, add	1-2 tbsp.	2-4 tbsp.	3-4 tbsp.

NOTE: Since every recipe is different, experimentation may be necessary to give you the desired result.

NOTE: The timer for delayed baking cannot be used with this setting because you will be removing the dough from the breadmaker to shape it and bake it in your conventional oven.

1. Get the bread pan ready.

- A. Open the lid of the breadmaker and remove the bread pan by lifting the pan handle.
- B. Install the kneading blade on the shaft inside the bread pan as the figure shows.

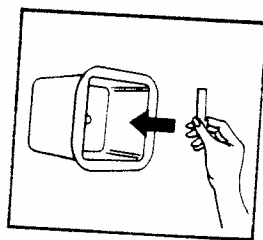

- C. Insert the kneading pin into the slot, making sure it clicks into place.
- NOTE: Be sure the kneading blade and pin are securely attached. If the operation, the dough will not be kneaded correctly and liquid may leak out of the kneading pin opening.

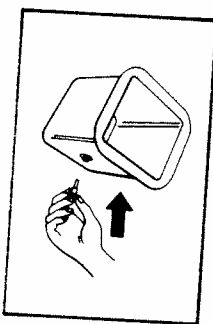

2. Measure ingredients into bread pan.

- A. Always put the water or other liquid in first.
- B. Then add flour, other dry ingredients and the yeast.

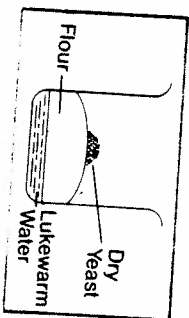

3. Place bread pan in breadmaker.

- A. Insert bread pan into oven area. Arrow (arrow at) mark indicates front side.

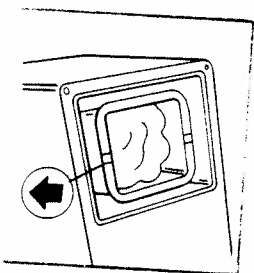

B. Pull handle of bread pan towards you and lay it down. Push the bread pan down until it clicks into place.

NOTE: If the bread pan is inserted with the kneading pin facing the wrong way, dough will not be kneaded. (The kneading pin will be on the right side.)

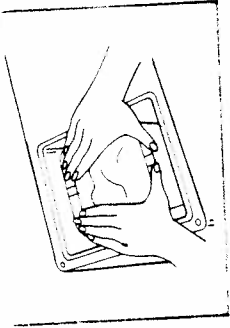

4. Start the breadmaker.

- Close the lid slowly using the cover handle.
- Plug in. The display will light up.
- Press MENU SELECT button to advance to the DOUGH setting. Time Display will indicate 1:25.
- Press the START button to begin the kneading process. Knead light will come on and the dots of the Time Remaining window will blink.



5. Remove the dough.

- After the eight beeps, push the STOP button.
- Open the lid and lift out the bread pan by the handle (the pan is not hot).
- Remove the dough. Punch dough down on a lightly floured surface.
- Follow the individual recipe instructions from this point.

Variations for Shaping Dough

Shape dough into your favorite shape (suggestions follow). Cover rolls with a clean cloth and let rise, until almost doubled in size, about 1 hour. Bake in preheated 350° F. oven 30-35 minutes, until golden brown. Remove from pans; cool on a wire rack or serve warm.

Easy Dinner Rolls

Divide dough into 12 equal pieces, shape into balls and place in greased muffin cups. Let rise and bake as directed.
Makes 12.



Swirls

Lightly grease baking sheet. Divide dough into 12 equal pieces. On a lightly floured surface, roll each piece into a pencil-like strand about 9 inches long. Beginning at center, make a loose swirl with each strand. Place 2-3 inches apart on prepared baking sheet. Let rise and bake as directed.
Makes 12.



Bow Knots

Lightly grease baking sheet. Divide dough into 12 equal pieces. On lightly floured surface, roll each piece into a pencil-like strand about 9 inches long. Form a loose knot. Place 2-3 inches apart on prepared baking sheet. Let rise and bake as directed.
Makes 12.



Cloverleaves

Lightly grease 12 muffin cups. Divide dough into 36 1-inch pieces. Pull edges under, smoothing tops to make balls. Place 3 balls in each muffin cup, smooth side-up. Let rise and bake as directed.
Makes 12.

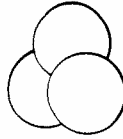

Does anything in the world smell as good as a loaf of homemade bread? You have purchased a Regal Automatic Breadmaker so you know you want to learn how to bake bread in your own home. If breadmaking is a new art to you, understanding more about it—common terms, kinds of ingredients, how to measure accurately—will help you become an expert. Read these pages and you're on your way to delicious bread baking.

Breadmaking Terms

- **Knead**
If working by hand, kneading means folding the dough towards you and then pushing it away with the heel of your hand in a rocking motion, rotating the dough a quarter turn. You repeat this until the dough is smooth and blistered. When using your Regal Breadmaker, this process is done automatically for you.
 - **Rise**
The dough is kept at the proper temperature to activate the yeast. By hand, you would put the dough in a bowl and cover it, keeping it out of drafts usually for an hour or more. This is done automatically with your Regal Breadmaker.
 - **Punch Down**
The gas trapped in the dough is pressed out to make a better dough. By hand, you would need to "punch down" the dough. Your breadmaker does this automatically! Only recipes on the DOUGH setting require punching down dough by hand and then shaping.
 - **Bake**
The rising of the dough is complete and the dough is transformed into bread by baking. Your breadmaker bakes the bread for you. With the DOUGH setting you can remove the dough at a specified time, shape it into rolls, pizza crust or whatever, and bake it in your conventional oven.
 - **Cool**
Hot bread done by hand needs to cool on wire racks. The bread made in your breadmaker can be removed while hot (about 20 minutes remaining on the timer), or allowed to cool automatically in your breadmaker. The last 20 minutes of the process is the automatic cool down.
- Use the package or 4-ounce jar as quickly as possible after opening. Check the date on the package to be sure your yeast is fresh.
 - For best results, measure ingredients precisely.
 - Timer: On BREAD setting, the preset timer is used. When using the timer for delayed baking, the resting time will be lengthened, which usually enhances the height of the bread. In warm weather conditions you may need to reduce the yeast ¼ teaspoon to prevent over rising.
 - To ensure tasty bread, slice hot, crusty bread with a sharp knife or an electric knife.
 - After cooling bread completely, store immediately in a tightly sealed plastic bag, plastic wrap or covered container.
 - For longer storage, seal baked bread tightly in moisture proof wrap or bag and store in freezer.

Ingredients Used for Breadmaking

Bread Flour
Bread Flour is milled especially for yeast baking. The higher amount of protein in bread flour significantly enhances its bread baking qualities, producing a better bread texture.

Whole Wheat Flour

A coarse textured flour ground from wheat kernels, whole wheat flour produces heavier, denser breads. In most recipes, whole wheat flour and white flour can be mixed 50/50 resulting in an excellent baked product.

Rye Flour

Rye Flour is a heavy flour with a low gluten content. It makes a very sticky dough and results in a moist, textured bread. There are four varieties of rye flour: white, medium, dark and pumpernickel.

Dry Yeast

When combined with sugar and water at the right temperature, the yeast generates carbon dioxide which makes the dough rise. Active dry yeast is recommended.

Hints for Baking Delicious Homemade Breads

- Use only fresh ingredients.
- Yeast is the most important ingredient in bread baking, causing the bread to rise. Too little yeast can result in improper rising. Too much yeast will cause the bread to fall when it starts baking. This breadmaker uses dry active yeast. In your breadmaker this yeast does not need preliminary fermentation. After opening, seal package and store the yeast in a cool, dry place.

WHITE BREAD

**Timer OK
Bread Setting**

- 1 cup water
- 1 tablespoon butter or margarine, softened
- 2 1/4 cups bread flour
- 1-2 tablespoons sugar
- 1 tablespoon dry milk solids
- 1 teaspoon salt
- 1 1/4 teaspoons dry active yeast

Follow instructions for Bread Setting.

RYE BREAD

**Timer OK
Bread Setting**

- 1 1/4 cups water
- 1 tablespoon butter or margarine, softened
- 2 1/2 cups bread flour
- 3/4 cup rye flour
- 1 1/2 tablespoons sugar or molasses
- 1 tablespoon caraway seed, optional
- 1 teaspoon salt
- 2 1/4 teaspoons dry active yeast

Follow instructions for Bread Setting.

NOTE: Due to the nature of rye flour, this recipe exceeds the recommended total of 3 cups flour. You will get a good size loaf with a full rye flavor.

OAT BRAN BREAD

**Timer OK
Bread Setting**

- 1 1/4 cups water
- 2 tablespoons butter or margarine, softened
- 2 1/4 cups bread flour
- 1/4 cup oat bran
- 1 tablespoon sugar
- 1 teaspoon salt
- 1 1/2 teaspoons dry active yeast

Follow instructions for Bread Setting.

OATMEAL BREAD

**Timer OK
Bread Setting**

- 1 1/2 - 1 1/4 cups water
- 1/4 cup honey or molasses
- 1 tablespoon butter or margarine, softened
- 2 cups bread flour
- 1/2 cup quick cooking oats
- 1 teaspoon salt
- 1 1/4 teaspoons dry active yeast

Follow instructions for Bread Setting.

WHOLE WHEAT CORNMEAL BREAD

**Timer OK
Bread Setting**

- 1 1/4 - 1 1/2 cups water
- 1/4 cup honey
- 2 tablespoons butter or margarine, softened
- 1 1/2 cups bread flour
- 1 cup whole wheat
- 1/2 cup cornmeal
- 1 teaspoon salt
- 1 1/4 teaspoons dry active yeast

Follow instructions for Bread Setting.

DELUXE WHITE BREAD

**No Delay
Bread Setting**

- 3/4 cup water
- 3/8 cup milk
- 1 tablespoon butter or margarine, softened
- 2 1/4 cups bread flour
- 2 tablespoons sugar
- 1 teaspoon salt
- 1 1/2 teaspoons dry active yeast

Follow instructions for Bread Setting.

CINNAMON BREAD

**Timer OK
Bread Setting**

- 1 1/4 cups water
- 1 tablespoon butter or margarine, softened
- 2 1/4 cups bread flour
- 2 tablespoons sugar
- 1 tablespoon dry milk solids
- 1 teaspoon salt
- 1 teaspoon cinnamon
- 1 1/4 teaspoons dry active yeast

Follow instructions for Bread Setting.

OAT WHEAT BREAD

**No Delay
Bread Setting**

- 3/4 cup water
- 1/4 cup cottage cheese
- 1/4 cup honey
- 1 egg
- 2 tablespoons butter or margarine, softened
- 2 cups bread flour
- 1/2 cup whole wheat flour
- 1/4 cup quick cooking oats
- 1 teaspoon salt
- 2 teaspoons dry active yeast

Follow instructions for Bread Setting.

EGG BREAD

No Delay Bread Setting

- 1 cup milk
- 1 egg
- 2 tablespoons butter or margarine, softened
- 2 1/4 cups bread flour
- 1-2 tablespoons sugar
- 1 teaspoon salt
- 1 1/4 teaspoons dry active yeast

Follow instructions for Bread Setting.

SWEET BREAD

No Delay Bread Setting

- 1 cup milk
- 1 egg
- 1 tablespoon butter or margarine, softened
- 2 1/4 cups bread flour
- 1/4 cup sugar
- 1 teaspoon salt
- 2 teaspoons dry active yeast

Follow instructions for Bread Setting.

WHOLE WHEAT BREAD

No Delay Bread Setting

- 1/2 cup water
- 1/2 cup milk
- 1 tablespoon butter or margarine, softened
- 1 tablespoon molasses
- 1 1/4 cups bread flour
- 1 cup whole wheat flour
- 2 tablespoons packed brown sugar
- 1 teaspoon salt
- 1 1/4 teaspoons dry active yeast

Follow instructions for Bread Setting.

POTATO BREAD

No Delay Bread Setting

- 1 cup water
- 1 egg
- 1 tablespoon butter or margarine, softened
- 2 cups bread flour
- 1/4 cup instant potato flakes
- 1 tablespoon dry milk solids
- 1 tablespoon sugar
- 1 teaspoon salt
- 1 1/2 teaspoons dry active yeast

Follow instructions for Bread Setting.

3. Pull handle of bread pan towards you and lay it down. Push the bread pan down until it clicks into place. 

4. Start the breadmaker.

- A. Close the lid slowly using the cover handle.
- B. Plug in. Display will light up.
- C. If you wish to delay the start time for baking, refer to page 9 on the TIME R. If you wish to bake immediately, press the START button. Note the KNEAD indicator light is on and the unit is running. The time display will show 3:30 (3 hours and 30 minutes) and is counting down.

The timer counts down by the minute.



NOTE: When using the BREAD setting, it is not necessary to press the MENU SELECT button. Operation begins automatically when the START button is pressed.

IMPORTANT: Weather conditions, storage of ingredients, and measuring ingredients all will alter the baked results. Adjustments can be made to compensate for these variables. Adjusting the liquid slightly is the easiest remedy.

When making bread by hand, the old fashioned way, the amount of flour is the control for adjusting. For example, most conventional bread recipes read: 6 to 7 cups flour. That 1 cup difference is the allowance to adjust the dough to the correct consistency. In the Automatic Breadmaker, the water adjustment can be made while the breadmaker is still mixing and kneading. Make the adjustment, 1 tablespoon at a time, within the first 25 minutes of the cycle. (The unit must be in the Mixing/Kneading cycle).

If the baked loaf falls while baking, too much liquid was used. Next time, reduce liquid.

If the bread is small, heavy or has a dense, moist texture, the dough was too dry. Next time, increase liquid.

Not all recipes will produce a 6 1/2 inch loaf. When using whole flours, wheats and grams, the bread will be smaller.

D) When the timer reaches :55, the breadmaker starts the baking cycle. Four beeps signal that the bread is baked and you may remove it at this time. The display window will read :22. Eight beeps signal that the cooling cycle is complete and the bread may be removed at this time. The display panel will read End.

CAUTION: After the breadmaker begins the baking stage, the breadmaker will become very hot. Do not touch the glass viewing window or place your hand over the air exhaust.

5. Remove the bread.

- A. When the beeps stop, push the STOP button.
- B. Open the lid and lift out the bread pan by the handle. Use pot holder or oven mitt.
- C. Remove the kneading pan.
- D. Turn bread pan upside down and shake gently to remove bread. Cool on wire rack.
- E. When cool, wrap bread in plastic wrap to prevent dryness.

NOTE: This is the only setting for which delayed time baking is possible. See page 9 for instructions on using the timer. Recipes in this section are given for no-delay baking and delayed timer baking.

1. Get the bread pan ready.

- A. Open the lid of the breadmaker and remove the bread pan by lifting the pan handle.
- B. Install the kneading blade on the shaft inside the bread pan as the figure shows.

C. Insert the kneading pin into the slot, making sure it clicks into place.

NOTE: Be sure the kneading blade and pin are securely attached. If the kneading pin releases during operation, the dough will not be kneaded correctly and liquid may leak out of the kneading pin opening.

2. Measure ingredients into bread pan in the order listed.

- A. Always put the water or other liquid in first.
- B. Then add flour and other dry ingredients, except yeast.
- C. Add dry yeast last to keep the yeast active. See figure.

IMPORTANT: For delayed baking, that is baking the bread at a later time (Time Set), be especially careful that the dry yeast doesn't contact the water. This would activate the yeast too early.

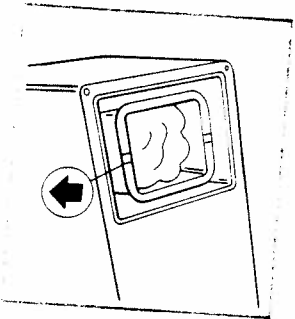
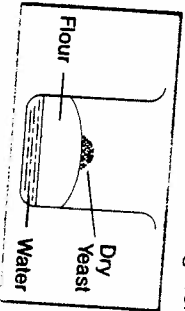
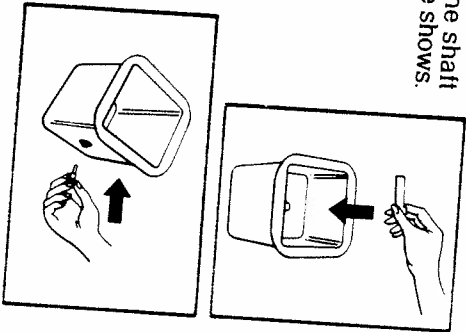

3. Place bread pan in breadmaker.

- A. Insert bread pan into oven area. Arrow (arrow art) mark indicates front side. The kneading pin will be on the right side of the pan.

NOTE: The timer for delayed baking cannot be used with this setting because you will add extra ingredients 25 minutes from the start. Four Deepes will signal you.

1. Get the bread pan ready.

- A. Open the lid of the breadmaker and remove the bread pan by lifting the pan handle.
- B. Install the kneading blade on the shaft inside the bread pan as the figure shows.

C. Insert the kneading pin into the slot, making sure it clicks into place.

NOTE: Be sure the kneading blade and pin are securely attached. If the kneading pin releases during operation, the dough will not be kneaded correctly and liquid may leak out of the kneading pin opening.

2. Measure ingredients into bread pan except for dried fruit, nuts, etc.

- A. Always put the water or other liquid in first.
- B. Then add flour and other ingredients, except yeast.
- C. Add the dry yeast last to keep the yeast active. See figure.

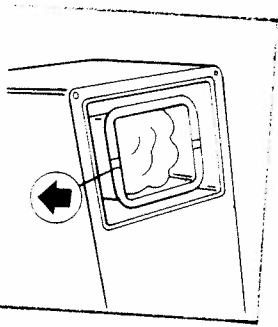
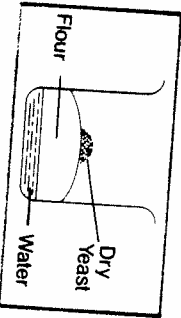
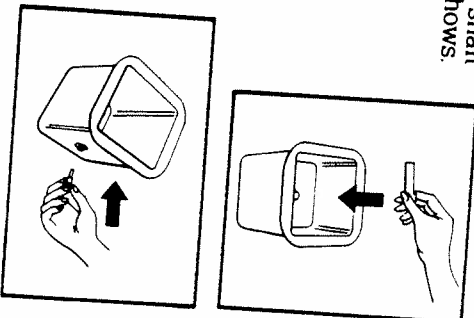

3. Place bread pan in breadmaker.

- A. Insert bread pan into oven area. Arrow (→) mark indicates front side.

B. Pull handle of bread pan towards you and lay it down. Push the bread pan down until it clicks into place.

NOTE: If the bread pan is inserted with the kneading pin facing the wrong way, the dough will not be kneaded. (The kneading pin will be on the right side of the pan.)

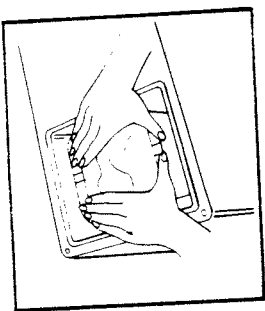

4. Start the breadmaker.

A. Close the lid slowly using the cover handle.

B. Plug in. The display will light up.

C. Press MENU SELECT button to the RAISIN BREAD setting.

Time Display will indicate 3:30.



D. Press the START button to begin the kneading process. Note the KNEAD light is on and the dots on the Time Set light will blink.

E. Adding extra ingredients:

About 25 minutes from the start and 5 minutes before the kneading is finished, the breadmaker will beep four times. At this signal, add dried fruit, nuts or whatever extra ingredient your recipe calls for. Time display will read 3:05.

Open the lid and sprinkle extra ingredients in quickly and evenly over the dough. Opening the lid at this time will not stop the kneading process, so be careful! Close the lid and the unit will continue through the remaining cycles.

Also, do not add extra ingredients before this signal. This could result in mashed raisins or nuts or colored dough – without a raisin or nut to be found! Improper timing could also result in dough that does not rise sufficiently.

NOTE: If you forgot to select the RAISIN BREAD setting with the MENU SELECT button, the beeps will not sound. You can still add the extra ingredients when the time remaining reads 3:05.

5. Removing the bread.

A. Eight beeps signal the end of the cooling cycle. When the beeps stop, push the STOP button.

B. Open the lid and lift out the bread pan by the handle. Use pot holder or oven mitt.

C. Remove the kneading pin.

D. Turn the bread pan upside down and shake gently to remove the bread. Cool on wire rack.

E. When cool, wrap bread in plastic wrap to maintain freshness.

To reduce rising time of dough prepared in your breadmaker

■ Preheat conventional oven to 200° F. for 5 minutes, then turn oven off. Shape dough; place on baking utensil; cover with a clean cloth. Place dough in oven until doubled in size. This will reduce rising time by about one-half.

■ If television is in use, let dough rise on top of set. It's a good source of heat and, if you're watching a program, you won't forget about the dough.

■ Recipes using whole grain or unrefined flours (these contain less gluten) may not rise as much as a white loaf. Heavier breads may fall slightly in the center. This is normal and will not affect the flavor or texture.

For best results, do not store unbaked yeast dough in your freezer for more than two weeks.

To freeze unbaked bread dough

■ Shape loaves and wrap in plastic film or foil. When you shape the loaf, be sure it fits easily into the baking pan as it will spread a little before freezing. Place wrapped loaf on a flat surface in your freezer so it will keep its shape until frozen.

■ To bake: Remove loaf from freezer and place in greased loaf pan (size specified in recipe). Let loaf thaw and rise in a warm place until almost doubled in size – about 6 hours for a standard size loaf. (Or thaw loaf in refrigerator overnight, then unwrap, put in loaf pan, and let rise in a warm place for approximately 2 hours.)

To freeze unbaked rolls

■ Shape rolls on greased baking sheets or in muffin pans as indicated in recipe. Cover pans and rolls with plastic film or foil and place in freezer. Rolls shaped in muffin pans are best frozen and stored in the pans. Rolls shaped on baking sheets should be removed as soon as they are completely frozen and placed in freezer bags or other freezer wrappings. Remember to label each package with date and quantity.

■ To bake: Remove rolls from freezer about 2 hours before baking. Place 1 inch apart on greased baking pans. Cover pans loosely with a clean cloth and set in a warm place to thaw and rise until almost doubled in size (approximately 1½ to 2 hours). Bake as directed in recipe.

■ Note: You can wrap and freeze dough right after the first rising and after you have punched it down. To use, thaw dough about 3 hours at room temperature or overnight in the refrigerator, then shape, let rise, and bake as directed in recipe.

Keeping your bread fresh

■ There are no preservatives in your homemade bread, so store cooled loaf in a tightly sealed plastic bag. Enclose a rib of celery in the bag to keep bread fresh longer.

CHOCOLATE NUT BREAD

Raisin Setting

- 1 cup water
- 1 egg
- 1 tablespoon butter or margarine,
softened
- 2¼ cups bread flour
- ¼ cup sugar
- 1 teaspoon salt
- 2 teaspoons dry active yeast
- ½ cup chocolate chips
- ½ cup chopped walnuts or pecans

Follow instructions for Raisin Setting.
When unit tones, add chocolate chips
and nuts.

CHEESY EGG BREAD

Raisin Setting

- 1 cup water
- 1 egg
- 2¼ cups bread flour
- 1 tablespoon sugar
- 1 teaspoon salt
- 1½ teaspoons dry active yeast
- 1 cup (4 ounces) shredded Cheddar
cheese, frozen

Follow instructions for Raisin Setting.
When unit tones, add cheese.



Baking bread in the Regal Automatic Breadmaker is easy and fun! Each step in the standard process of making bread is shortened and actually done for you. Review the directions for each of the three settings – and experiment with the scrumptious recipes we've included for you.

Three Basic Bread Settings

Your Regal Automatic Breadmaker has three settings – BREAD – RAISIN BREAD – DOUGH. Select one of these settings depending on the kind of bread you wish to make.

Bread Setting

This setting is used when you want the breadmaker to knead, shape, allow to rise and bake a loaf of bread. All you have to do is put in the ingredients in the order listed and press the START button. Everything is automatic from kneading to baking. A finished loaf takes 3 hours and 30 minutes, approximately. Four beeps signal the end of the Bake cycle. You may remove the bread at this time or leave it in the breadmaker to cool. Eight beeps signal that the bread has cooled and you may remove it. The display panel will read End.

Raisin Bread Setting

This setting is used when you want the breadmaker to knead, shape, allow to rise and bake a loaf of raisin, nut or fruit bread. About 1 hour and 30 minutes from the start and 5 minutes before the kneading is finished, the breadmaker signals you with four beeps. At this time you add raisins, nuts, fruit or whatever extra ingredient your recipe calls for. NOTE: The display will read 3:05.

Dough Setting

This setting is used for bread or rolls which are shaped by hand before baking in your conventional oven. The dough is kneaded and rises once in 1 hour and 25 minutes. Then, you remove the dough from the bread pan, shape it by hand and bake it according to the recipe directions.

Milk and water are interchangeable in these recipes. Milk gives bread a velvety grain and adds nutrients. Breads made with water have a heavier, crisper crust.

In place of granular (white) sugar, you may use brown sugar, honey, molasses or syrups. (Hint: Before measuring honey or molasses, oil the measuring spoons or cup with cooking oil. The sticky syrup easily runs off the utensil.)

To make yeast breads last longer and be slightly larger, use water in which you've cooked potatoes.

In a cool room, substitute warm water (110-115°) where recipe calls for tap water.

Vegetable oil can replace butter or margarine.

Lite salt instead of regular salt is an excellent substitute.

There are several bread mixes available on the market which can also be used in your Regal Breadmaker. Follow the package instructions to make one loaf (1-1½ pounds).

RAISIN BREAD

Raisin Setting

- 1¼ cups water
- 1 tablespoon butter or margarine, softened
- 2¼ cups bread flour
- 2 tablespoons sugar
- 1 tablespoon dry milk solids
- 1 teaspoon salt
- 1 teaspoon cinnamon
- 1¼ teaspoons dry active yeast
- 1 cup raisins

Follow instructions for Raisin Setting. When unit tones, add raisins.

Variations: Add ½ cup chopped walnuts or pecans at the same time as the raisins.

SAVORY ITALIAN BREAD

Raisin Setting

- 1¼ cups water
- 1 teaspoon olive oil
- 2 cups bread flour
- ¼ cup whole wheat flour
- 1 tablespoon sugar
- 1 tablespoon dry milk solids
- 1 tablespoon Parmesan cheese
- 1 teaspoon Italian herb seasoning
- 1 teaspoon instant minced onion
- 1 teaspoon salt
- 1½ teaspoons dry active yeast
- ½ cup (2 ounces) shredded Swiss cheese
- ½ cup minced pepperoni

Follow instructions for the Raisin Setting. When unit tones, add cheese and pepperoni.

DRIED FRUIT BREAD

Raisin Setting

- 1¼ cups water
- 1 tablespoon butter or margarine, softened
- 2¼ cups bread flour
- 2 tablespoons sugar
- 1 tablespoon dry milk solids
- 1 teaspoon salt
- 1 teaspoon cinnamon
- 1¼ teaspoons dry active yeast
- 1 cup mixed dried fruit bits

Follow instructions for Raisin Setting. When unit tones, add fruit bits.

WHEAT AND SEED BREAD

Raisin Setting

- ¾ cup + 2 tablespoons water
- 2 tablespoons oil
- 2 tablespoons molasses
- 1 egg
- 2 cups bread flour
- ½ cup whole wheat flour
- 1 tablespoon sugar
- 1 teaspoon salt
- ¼ teaspoon curmin
- 1¾ teaspoons dry active yeast
- ½ cup salted sunflower seed nuts
- 1 tablespoon sesame seeds

Follow instructions for Raisin Setting. When unit tones, add sunflower nuts and sesame seeds.